



NOVO HORIZONTE ALUMÍNIOS

Missão:

Identificar e atender de maneira eficiente às necessidades e expectativas de nossos clientes; oferecendo produtos e serviços de qualidade com garantia, segurança e rapidez.

A Novo Horizonte Aluminios, vem conquistando espaço no mercado de extrudados de alumínio, através do fornecimento de produtos com qualidade, prazo de entrega reduzido, suporte no desenvolvimento de produtos específicos para atender as necessidades de seus clientes.

Instalada em Cambé, PR, em uma área de 4.500 m², a Novo Horizonte Aluminios conta com estrutura composta de equipamentos sofisticados, configurados com as melhores tecnologias disponíveis para o segmento. Desta forma garantimos atender ao mesmo tempo os requisitos técnicos do produto e os critérios de qualidade exigidos pelo mercado. Nas instalações da Novo Horizonte Aluminios, um novo produto solicitado é projetado em softwares avançados, e o ferramental executado em equipamentos de usinagem e erudição dinâmicos, com alta produtividade e minuciosa precisão, aliado a um corpo técnico devidamente capacitado, garantindo ao cliente a rapidez que ele precisa para atender o mercado em que atua.

Com o objetivo de garantir rapidez na entrega a empresa mantém internamente um Centro de Distribuição com produtos de alto giro, além de frota própria, que contribui para a eficiência logística. Os produtos após rigorosa inspeção são embalados de forma a garantir a sua qualidade durante o manuseio e transporte. Todo volume é identificado com os dados básicos possuindo também a informação de produção que garante toda a rastreabilidade do processo.

Com tudo isso, sua satisfação como cliente é garantida!



**NOVO
HORIZONTE**
ALUMÍNIOS

ÍNDICE

A	AQUECEDOR	47
	ARO PARA BICICLETA	19-20
B	BARCO	17-18
	BARRA CHATA	11
C	CAMINHÃO – TRILHO PARA CABINES	20
	CAMINHÃO – PROTEÇÃO LATERAL	21-25
	CAMINHÃO – DIVERSOS	26-28
	CAMINHÃO – TIRA FINA	29
	CANTONEIRA ABAS DESIGUAIS	9
	CANTONEIRAS ABAS IGUAIS	9
	CANTONEIRAS ARREDONDADAS ABAS IGUAIS	10
E	ESCADAS	16
F	FERRAGEM	41-44
	FOTOVOLTAICO	30
L	LINHA CIVIL	12-14
	LINHA CASE	31
	LINHA DOMESTICA (TRILHOS)	15-16
	LINHA GRADIL	45
	LINHA SEGURANÇA	46
M	MODULO ESPECIAL	59
	MOVELEIRA	32-40
P	PERFIL “U” ABAS DESIGUAIS	10
	PERFIL “U” ABAS IGUAIS	10
T	TEMPERADO 10mm	50-55
	TEMPERADO BOX 8mm	48-49
	TRILHO PANTOGRÁFICO	56-58
	TUBO ELIPTICO	7
	TUBO QUADRADO	6
	TUBO QUADRADO – CANTOS ARREDONDADOS	6
	TUBO REDONDO ESTRIADO	5
	TUBO REDONDO LISO	4-5
	TUBO RETANGULAR	7
V	VENEZIANA	56
	VERGALHÃO QUADRADO	8
	VERGALHÃO REDONDO	8

OBSERVAÇÕES:

- ✓ PRODUTOS COM CÓDIGO SUBLINHADO, É COMERCIALIZADO NO QUILO SOB DEMANDA. FAVOR CONSULTAR A QUANTIDADE MÍNIMA ANTES DA CONCLUSÃO DA VENDA. EXEMPLO: 600018738
- ✓ TODOS OS ITENS DO CATÁLOGO ESTÃO SUJEITOS A VARIAÇÃO DE PESO DE $\pm 5\%$
- ✓ TODOS OS DESENHOS DE PRODUTOS ESTÃO EM ESCALA 1:1 (APROXIMADA)
- ✓ TRABALHAMOS COM DESENVOLVIMENTO DE FERRAMENTAS COM APLICAÇÕES ESPECÍFICAS. PROCURE NOSSO DEPARTAMENTO COMERCIAL.

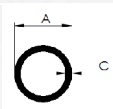

TUBO REDONDO LISO

CÓDIGO	PESOS*		MILÍMETRO		POLEGADA		EMBALAGEM PADRÃO (BARRAS)
	kg/m	BARRA 6 m	A	C	A	C	
600010012	0,075	0,450	7,94	1,35	5/16	1,35	50
600010004	0,069	0,414	9,52	0,90	3/8	-	50
600011052	0,094	0,564	9,52	1,25	3/8	-	20
<u>600018738</u>	0,166	1,050	9,52	3	3/8	-	20
600010006	0,104	0,624	12,7	1,0	1/2	-	20
600018740	0,136	0,816	12,7	1,35	1/2	-	20
600010818	0,158	0,948	12,7	1,6	1/2	1/16	20
<u>600018664</u>	0,074	0,504	14,29	0,7	9/16	-	50
<u>600018663</u>	0,103	0,618	14,29	0,85	9/16	-	50
<u>600012916</u>	0,160	0,960	14,29	1,4	9/16	-	30
<u>600018589</u>	0,120	0,720	15,87	0,8	5/8	-	30
600010027	0,169	1,014	15,87	1,3	5/8	-	30
600010002	0,180	1,080	15,87	1,4	5/8	-	30
600012137	0,204	1,224	15,87	1,6	5/8	1/16	30
<u>600018746</u>	0,247	1,482	15,87	2,0	5/8	-	20
600014172	0,300	1,800	15,87	2,5	5/8	-	20
<u>600010011</u>	0,536	3,216	19,00	4,0	-	-	10
<u>600011591</u>	0,129	0,774	19,05	0,8	3/4	-	30
600011592	0,162	0,972	19,05	1	3/4	-	30
600010026	0,206	1,236	19,05	1,3	3/4	-	20
600018741	0,220	1,320	19,05	1,4	3/4	-	20
600013903	0,250	1,500	19,05	1,6	3/4	1/16	20
600010010	0,315	1,890	19,05	2,0	3/4	-	20
<u>600010031</u>	0,125	0,750	22,22	0,65	7/8	-	20
600010025	0,154	0,924	22,22	0,8	7/8	-	20
600012203	0,190	1,140	22,22	1	7/8	-	20
600010001	0,260	1,560	22,22	1,4	7/8	-	20
600011615	0,294	1,764	22,22	1,6	7/8	1/16	20
600010015	0,401	2,406	22,22	2,0	7/8	-	15

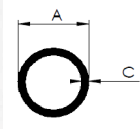

TUBO REDONDO LISO

CÓDIGO	PESOS*		MILÍMETRO		POLEGADA		EMBALAGEM PADRÃO (BARRAS)
	kg/m	BARRA 6 m	A	C	A	C	
600010028	0,177	1,062	25,4	0,8	1	-	20
600018731	0,218	1,308	25,4	1	1	-	20
600018742	0,304	1,824	25,4	1,4	1	-	20
600011560	0,336	2,016	25,4	1,6	1	1/16	15
600018733	0,418	2,508	25,4	2	1	-	10
600018732	0,600	3,600	25,4	3	1	-	10
600018611	0,195	1,170	28,58	0,8	1.1/8	-	12
600018610	0,247	1,485	28,58	1	1.1/8	-	12
600010008	0,315	1,890	28,58	1,3	1.1/8	.	12
600018609	0,276	1,656	31,75	1	1.1/4	-	12
600010007	0,378	2,268	31,75	1,4	1.1/4	-	15
600012200	0,430	2,583	31,75	1,6	1.1/4	1/16	12
600012202	0,534	3,204	31,75	2	1.1/4	-	10
600010019	0,553	3,318	33,8	1,95	-	-	10
600018735	0,333	1,999	38,1	1	1.1/2	-	16
600012201	0,491	2,946	38,1	1,5	1.1/2	-	12
600010017	1,390	8,340*	48,00	3,5	-	-	3
600010032	0,610	3,660	44,45	1,6	1,3/4	1/16	8
600011104	0,535	3,210	50,8	1,2	2	-	6
600018739	0,787	4,725	50,8	1,8	2	-	6
600018745	0,554	3,324	33,8	1,95	-	-	6

*Material fornecido em barras de 2,4 metros

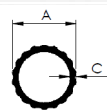

TUBO REDONDO ESTRIADO

CÓDIGO	PESOS*		MILÍMETRO		POLEGADA		EMBALAGEM PADRÃO (BARRAS)
	kg/m	BARRA 6 m	A	C	A	C	
600010013	0,120	0,720	22,22	0,95	7/8	-	20
600010014	0,141	0,846	25,40	0,95	1	-	15
600010029	0,175	1,050	28,58	0,65	1.1/8	-	10
600010459	0,210	1,260	28,58	1	1.1/8	-	10
600010030	0,195	1,170	31,75	0,65	1.1/4	-	10
600010458	0,231	1,386	31,75	1	1.1/4	-	10

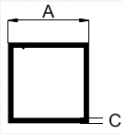

TUBO QUADRADO

CÓDIGO	PESOS*		MILÍMETRO		POLEGADA		EMBALAGEM PADRÃO (BARRAS)
	kg/m	BARRA 6 m	A	C	A	C	
601060001	0,192	1,152	15,88	1,1	5/8	-	20
601060002	0,300	1,800	19,05	1,5	3/4	-	20
601068711	0,308	1,848	19,5	1,5	-	-	16
601060009	0,178	1,068	23,0	0,7	-	-	15
601063492	0,193	1,158	25,4	0,7	1	-	15
601068244	0,330	1,980	25,4	1,2	1	-	16
601062967	0,408	2,448	25,4	1,5	1	-	12
601060004	0,228	1,764	29,4	0,7	-	-	12
601068528	0,418	2,508	31,75	1,2	1.1/4	-	12
601060008	0,902	5,412	31,75	2,8	1.1/4	-	6
601062168	0,341	2,046	38,1	0,85	1.1/2	-	12
601067688	0,504	3,024	38,1	1,2	1.1/2	-	12
601063344	0,625	3,750	38,1	1,5	1.1/2	-	9
601060013	1,257	7,542	38,1	3,0	1.1/2	-	4
601060011	0,390	2,658	40,0	1	-	-	9
601060005	0,676	4,056	50,8	1,2	2	-	6
601068469	0,733	4,398	50,8	1,3	2	-	6
601060003	0,800	4,800	50,8	1,5	2	-	6
601063720	0,977	5,862	50,8	1,75	2	-	6

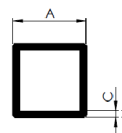

TUBO QUADRADO - CANTOS ARREDONDADOS

CÓDIGO	PESOS*		MILÍMETRO		POLEGADA		EMBALAGEM PADRÃO (BARRAS)
	kg/m	BARRA 6 m	A	C	A	C	
601068736	0,357	2,142	25,4	1,3	1	-	10
601062968	0,532	3,194	25,4	2	1	-	12

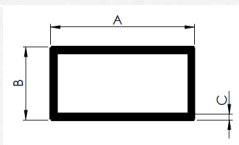

TUBO RETANGULAR

CÓDIGO	PESOS*		MILÍMETRO			POLEGADA			EMBALAGEM PADRÃO (BARRAS)
	kg/m	BARRA 6 m	A	B	C	A	B	C	
601071590	0,154	0,930	25,4	12,7	0,75	1	1/2	-	30
<u>601070016</u>	0,263	1,578	25,4	12,7	1,3	1	1/2	-	15
<u>601071674</u>	0,523	3,138	30	20	2,0	-	-	-	10
601070013	0,301	1,806	50,8	9,52	1,0	2	3/8	-	3
601071589	0,313	1,878	50,8	25,4	0,7	2	1	-	10
601071588	0,665	3,990	50,8	25,4	1,6	2	1	1/16	8
601070006	0,584	3,504	50,8	25,4	1,4	2	1	-	10
601070003	0,919	5,514	76,2	38,1	1,45	3	1.1/2	-	4
601070007	1,148	6,888	101,6	50,8	1,35	4	2	-	3
<u>601071593</u>	1,260	7,560	50	30	3,0	-	-	-	3

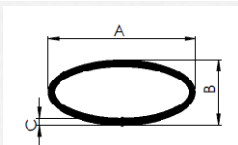

TUBO ELIPTICO

CÓDIGO	PESOS*		MILÍMETRO			EMBALAGEM PADRÃO (BARRAS)
	kg/m	BARRA 6 m	A	B	C	
601110001	0,378	2,268	35	20	1,6	10
<u>601110008</u>	0,395	2,370	45	21	1,4	10
601110002	0,457	2,742	45	20	1,6	10
<u>601110003</u>	0,510	3,061	45	20	1,8	10
<u>601110007</u>	0,490	2,940	46,7	22	1,6	10



VERGALHÃO QUADRADO*

CÓDIGO	PESOS		MILÍMETRO	POLEGADA	EMBALAGEM PADRÃO (BARRAS)
	kg/m	BARRA 6 m	A	A	
601100269	0,103	0,617	6	-	10
601100001	0,180	1,080	7,93	5/16	10
601100007	0,258	1,548	9,53	3/8	20
601107465	0,447	2,682	12,7	1/2	10
601108759	0,714	4,284	15,87	5/8	8
601100008	1,403	8,418	22,22	7/8	6

Material impróprio para grandes usinagens (Liga 6063 T5)

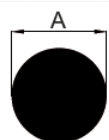

VERGALHÃO REDONDO*

CÓDIGO	PESOS		MILÍMETRO	POLEGADA	EMBALAGEM PADRÃO (BARRAS)
	kg/m	BARRA 6 m	A	A	
601100005	0,068	0,408	5,5	-	10
601107659	0,081	0,486	6,0	-	10
601101675	0,090	0,540	6,35	1/4	10
601108641	0,141	0,846	7,94	5/16	10
601107561	0,203	1,218	9,52	3/8	10
601100009	0,276	1,656	11,11	7/16	15
601101676	0,360	2,160	12,7	1/2	10
601100002	0,560	3,360	15,87	5/8	10
601108758	0,810	4,860	19,05	3/4	8
601100003	1,099	6,594	22,22	7/8	6
601100004	1,436	8,616	25,4	1	4
601100006	5,760	11,520**	50,8	2	2

*Material impróprio para grandes usinagens (Liga 6063 T5) (**) barras somente com 2 metros.

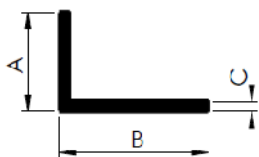

CANTONEIRA ABAS DESIGUAIS

CÓDIGO	PESOS*		MILÍMETRO			EMBALAGEM PADRÃO (BARRAS)
	kg/m	BARRA 6 m	A	B	C	
601000012	0,305	1,830	12,0	38,0	2,3	16
601000011	0,242	1,452	12,2	29,7	2,2	16
601003509	0,348	2,088	12,7	50,8	2	10
601003515*	0,784	4,704	15	50,8	4,5	5
601003505	0,233	1,398	16	40	1,5	10
601003506	0,276	1,656	18	48	1,5	10
601003516	0,987	5,922	25	55	4,6	6

(*) Parede da cota 15mm possui espessura 7,5mm.

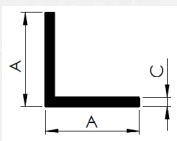

CANTONEIRA ABAS IGUAIS

CÓDIGO	PESOS*		MILÍMETRO		POLEGADA		EMBALAGEM PADRÃO (BARRAS)
	kg/m	BARRA 6 m	A	C	A	C	
601000004	0,053	0,318	12,7	0,7	1/2	-	30
601003511	0,083	0,498	12,7	1,2	1/2	-	10
601002196	0,062	0,372	15,87	0,7	5/8	-	30
601003513	0,099	0,594	15,87	1,2	5/8	-	10
601002197	0,075	0,450	19,05	0,7	3/4	-	30
601003512	0,126	0,756	19,05	1,2	3/4	-	10
601003518	0,283	1,698	22,22	2,38	7/8	3/32	10
601000185	0,099	0,594	25,4	0,75	1	-	30
601003510	0,169	1,014	25,4	1,2	1	-	10
601000019	0,209	1,254	25,4	1,5	1	1/16	10
601002198	0,430	2,580	25,4	3,17	1	1/8	10
601003504	0,542	3,252	31,75	3,17	1.1/4	1/8	10
601000014	0,585	3,510	38,10	3,17	1.1/2	1/8	8
601003508	0,887	5,322	50,8	3,17	2	1/8	5
601000016	1,303	7,860	50,8	4,76	2	3/16	4

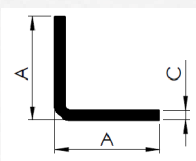

CANTONEIRA ARREDONDADA ABAS IGUAIS

CÓDIGO	PESOS*		MILÍMETRO		POLEGADA		EMBALAGEM PADRÃO (BARRAS)
	kg/m	BARRA 6 m	A	C	A	C	
601000007	0,049	0,294	12,70	0,7	1/2	-	30
601000008	0,062	0,372	15,87	0,7	5/8	-	30
601000009	0,075	0,450	19,05	0,7	3/4	-	30
601000010	0,100	0,600	25,4	0,7	1	-	30

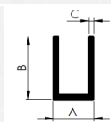

PERFIL "U" ABAS DESIGUAIS

CÓDIGO	PESOS		MILÍMETRO			EMBALAGEM PADRÃO (BARRAS)
	kg/m	BARRA 6 m	A	B	C	
<u>601220002</u>	0,136**	0,822	25	12,7	1	30
601220005	0,137***	0,822	36	20,0	0,7	20
<u>601220001</u>	0,208**	1,248	50	12,7	1	10

(**) Produtos utilizados geralmente para fachada de muro

(***) Desempeno

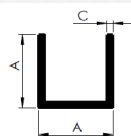

PERFIL "U" ABAS IGUAIS

CÓDIGO	PESOS		MILÍMETRO			EMBALAGEM PADRÃO (BARRAS)
	kg/m	BARRA 6 m	A	B	C	
601222200	0,068	0,408	9,52	-	1	20
601222199	0,095	0,570	12,7	-	1	20
601220003	0,286	1,716	12,7	-	1/8	10
601228715	0,148	0,888	15,87	-	1,3	20

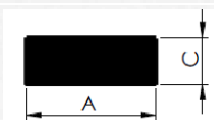

BARRA CHATA

CÓDIGO	PESOS*		MILÍMETRO		POLEGADA		EMBALAGEM PADRÃO (BARRAS)
	kg/m	BARRA 6 m	A	C	A	C	
601090023	0,064	0,384	12,7	2,00	1/2	-	50
601090713	0,113	0,678	12,7	3,17	1/2	1/8	10
601090018	0,228	1,368	12,7	6,35	1/2	1/4	15
601095091	0,141	0,846	15,87	3,17	5/8	1/8	10
601092974	0,213	1,278	15,87	4,76	5/8	3/16	10
601098041	0,287	1,722	15,87	6,35	5/8	1/4	10
601090634	0,173	1,038	19,05	3,17	3/4	1/8	10
601095092	0,259	1,554	19,05	4,76	3/4	3/16	10
601095302	0,342	2,052	19,05	6,35	3/4	1/4	10
601090014	0,505	3,03	19,05	9,5	3/4	3/8	10
601090001	0,200	1,200	22,22	3,17	7/8	1/8	10
601094936	0,230	1,380	25,4	3,17	1	1/8	10
601090007	0,286	1,716	31,75	3,17	1.1/4	1/8	10
601090631	0,573	3,438	31,75	6,35	1.1/4	1/4	8
601090637	0,859	5,154	31,75	9,52	1.1/4	3/8	5
601090017*	0,872	5,232	31,75	9,52	1.1/4	3/8	5
601095094	0,343	2,058	38,1	3,17	1.1/2	1/8	10
601090006	0,514	3,084	38,1	4,76	1.1/2	3/16	10
601090004	0,688	4,128	38,1	6,35	1.1/2	1/4	8
601090016	1,017	6,102	38,1	9,5	1.1/2	3/8	5
601090019	0,367	2,202	43,0	3,0	-	-	10
601090020	0,409	2,454	48,0	3,0	-	-	10
601095095	0,457	2,742	50,8	3,17	2	1/8	10
601097480	0,689	4,134	50,8	4,76	2	3/16	5
601090002	0,913	5,478	50,8	6,35	2	1/4	5
601098527	1,148	6,888	50,8	7,93	2	5/16	5
601091510	1,376	8,256	50,8	9,52	2	3/8	3
601090003	1,835	11,010	50,8	12,7	2	1/2	3
601090013	2,29	13,710	50,8	15,87	2	5/8	2
601098525	0,573	3,438	63,5	3,17	2.1/2	1/8	5
601090008	0,688	4,128	76,2	3,17	3	1/8	5
601090022	1,306	7,836	76,2	6,34	3	1/4	4
601090009	1,368	8,208	101,6	4,76	4	3/16	3
601098526**	1,446	7,230 (5m)	101,6	5	4	13/64	3
601090021**	2,750	13,750 (5m)	101,6	9,52	4	3/8	2
601090024	0,613	3.864	115	2	-	-	5

*CANTO ARREDONDADO - **BARRAS COM 5 METROS

LINHA CIVIL

CANTONEIRA SEXTAVADA ALTA

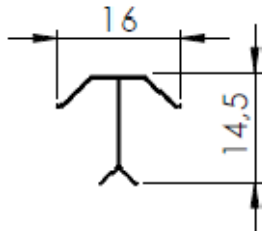

PESO 0,063 kg/m
30 BARRAS POR PACOTE
601000001

CANTONEIRA REDONDA

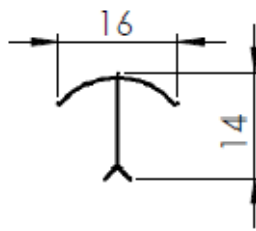

PESO 0,059 kg/m
30 BARRAS POR PACOTE
601000002

RODAPÉ DE PAREDE

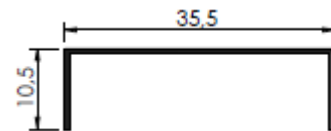

PESO 0,099 kg/m
30 BARRAS POR PACOTE
601050001

CONTRA MARCO

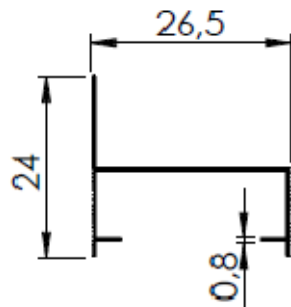

PESO 0,137 kg/m
30 BARRAS POR PACOTE
601151554

CANTO DE ESCADA

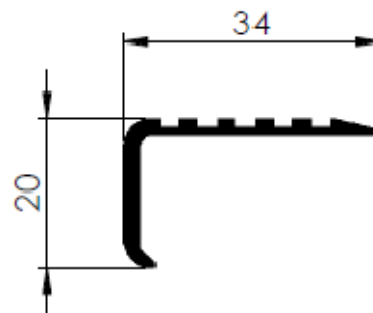

PESO 0,329 kg/m
10 BARRAS POR PACOTE
601003507

CHAPA PASSADEIRA PARA CARPETE

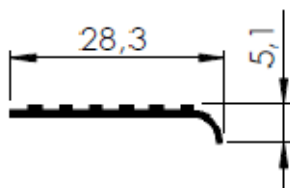

PESO 0,097 kg/m
10 BARRAS POR PACOTE
601130003

“T” PARA FORROS

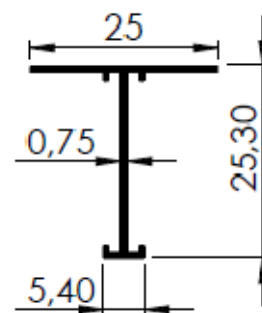

PESO 0,120 kg/m
20 BARRAS POR PACOTE
601130004

LINHA CIVIL

REGUA PRATICA - (SEM TAMPA)

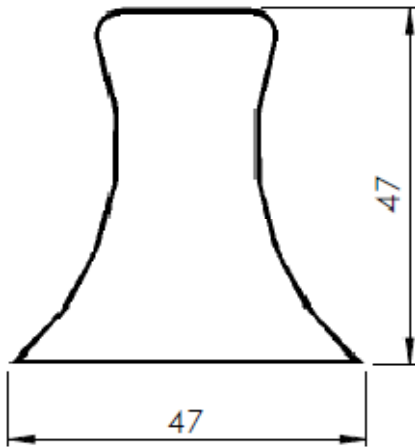

600020010 - PESO 0,330 kg/m
6 BARRAS POR PACOTE

REGUA BITUBULAR 3 X 1 (TAMPA LARANJA)

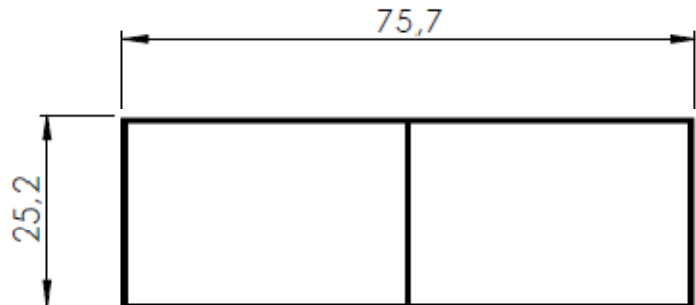

600020002 - PESO 0,444 kg/m - 6 BARRAS POR PACOTE

TEMOS TAMBÉM

601070005 - PESADA SEM TAMPA - LINHA MOVELERIA

PESO 0,924 kg/m - 6 BARRAS POR PACOTE

REGUA P/ DESEMPENO DE PISO 3" X 1.1/2" X 1,3MM (S/ TAMPA)

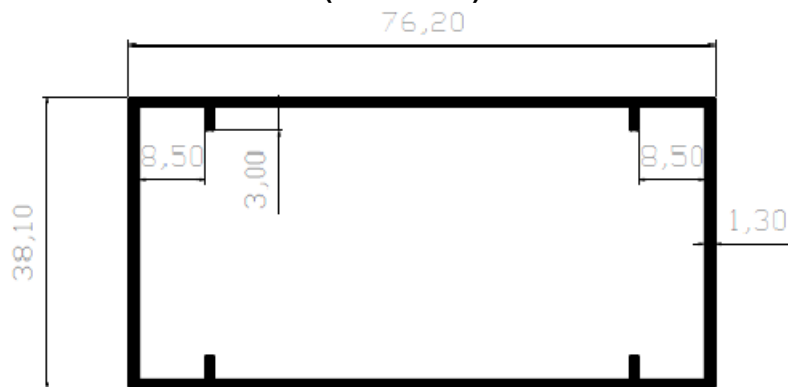

600020015 - PESO 0,873 kg/m - 6 BARRAS POR PACOTE

REGUA BITUBULAR "FINA" 2 X 1/2 (SEM TAMPA)

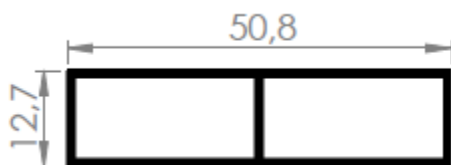

600020003 - PESO 0,289 kg/m 6 BARRAS POR PACOTE

TEMOS TAMBÉM

600020012 - PESADA SEM TAMPA - MOVELERIA

PESO 0,382 kg/m 10 BARRAS POR PACOTE

REGUA BITUBULAR "COMERCIAL" (TAMPA VERDE)

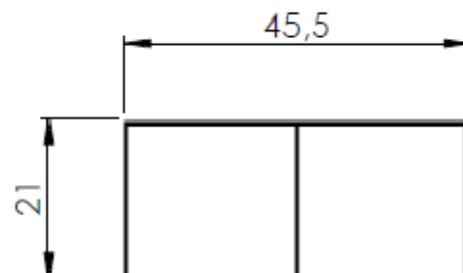

600020006 - PESO 0,263 kg/m - 6 BARRAS POR PACOTE

LINHA CIVIL

REGUA BITUBULAR (TAMPA AZUL)

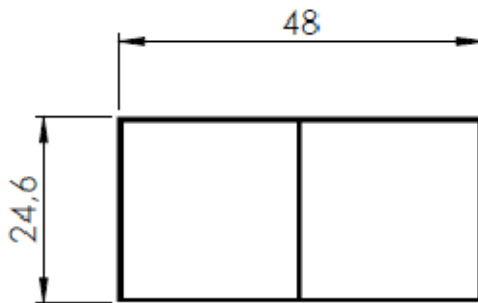

600020001 - PESO 0,300 kg/m
6 BARRAS POR PACOTE

REGUA BIT. EXTRA COMERCIAL (TAMPA CINZA)

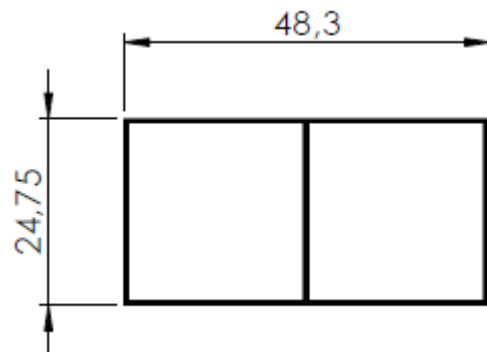

600020011 - PESO 0,378 kg/m
6 BARRAS POR PACOTE

REGUA BIT. EXTRA (TAMPA VERMELHA)

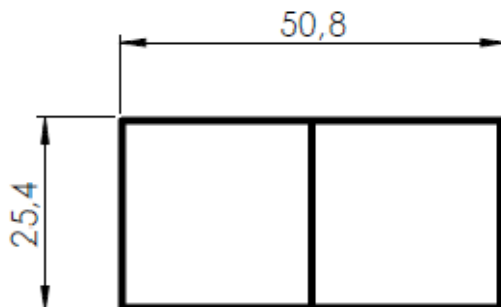

600020004 - PESO 0,475 kg/m
6 BARRAS POR PACOTE

REGUA LISA (TAMPA BRANCA)



600020014 - PESO 0,223 kg/m
6 BARRAS POR PACOTE

REGUA FRISADA (TAMPA AMARELA)

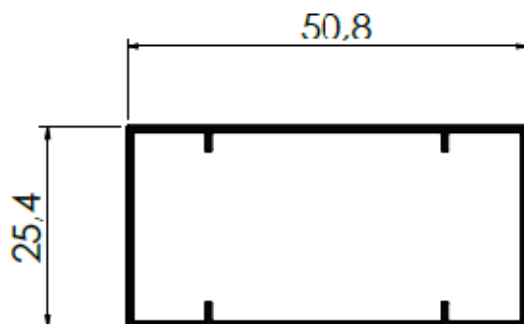

600022288 - PESO 0,344 kg/m
6 BARRAS POR PACOTE

REGUA FRISADA EXTRA (TAMPA BORDÔ)

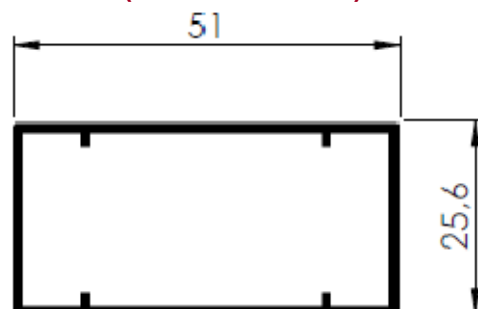

600028203 - PESO 0,565 kg/m
6 BARRAS POR PACOTE

LINHA DOMESTICA

TRILHO P/ CORTINA DUPLO

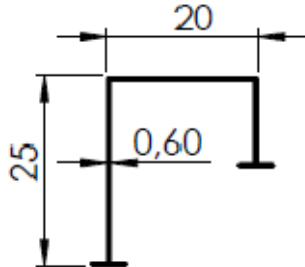

601020001 - PESO 0,105 kg/m
10 BARRAS POR PACOTE

TRILHO P/ CORTINA DUPLO ESPECIAL

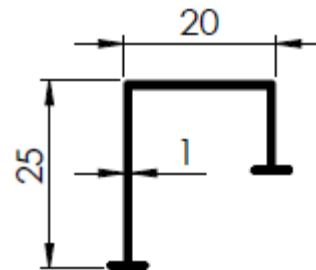

601020004 - PESO 0,129 kg/m
10 BARRAS POR PACOTE

TRILHO P/ CORTINA TRIPLO

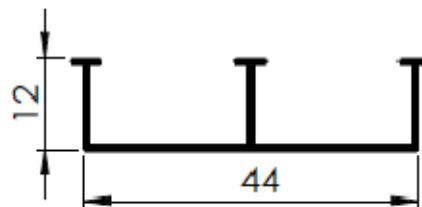

601020002 - PESO 0,147 kg/m
10 BARRAS POR PACOTE

TRILHO SUIÇO MONO

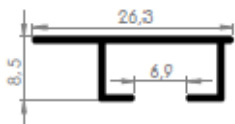

601020005 - PESO 0,107 kg/m
20 BARRAS POR PACOTE

TRILHO SUIÇO DUPLO

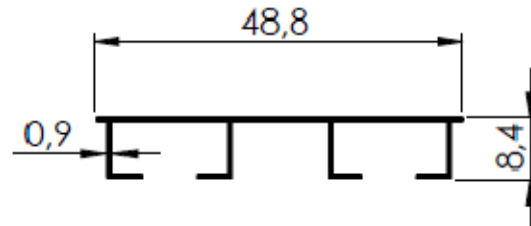

601020006 - PESO 0,241 kg/m
10 BARRAS POR PACOTE

TRILHO SUIÇO TRIPLO

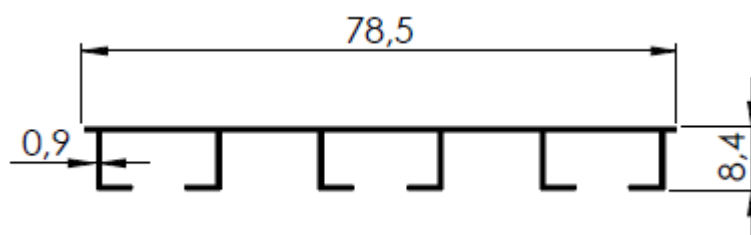

601020007 - PESO 0,375 kg/m
10 BARRAS POR PACOTE

LINHA DOMESTICA

TRILHO SUIÇO MONO C/ BANDÔ

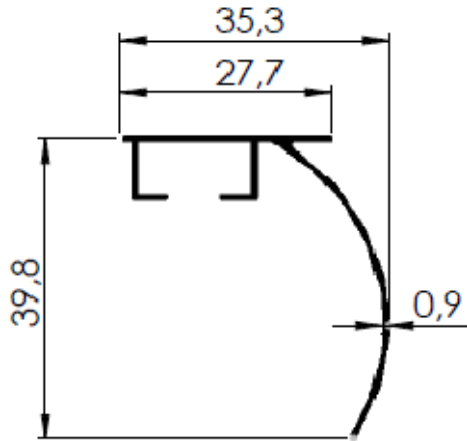

601020008 - PESO 0,244 kg/m
10 BARRAS POR PACOTE

TRILHO SUIÇO DUPLO C/ BANDÔ

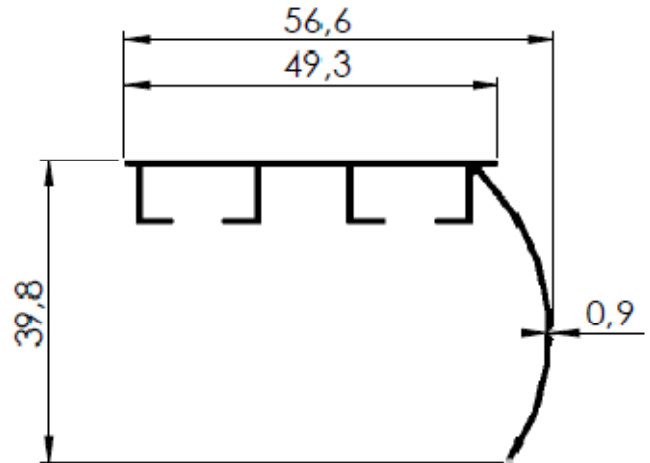

601020009 PESO 0,355 kg/m - 10 BARRAS POR PACOTE

ESCADA

DEGRAU TUBULAR

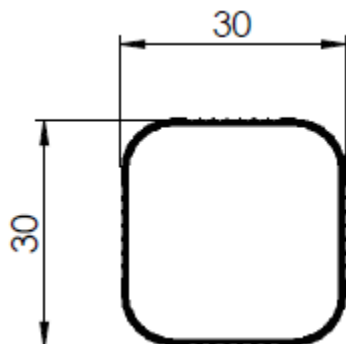

601130025 - PESO 0,330 kg/m
10 BARRAS POR PACOTE

DEGRAU RETANGULAR

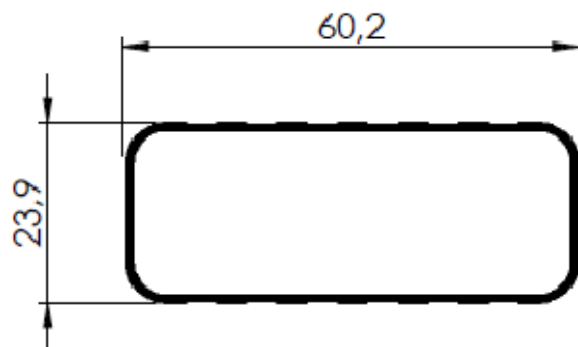

601130024 - PESO 0,541 kg/m - 10 BARRAS POR PACOTE

DEGRAU REDONDO

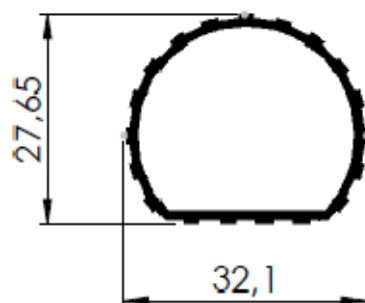

601130023 - PESO 0,376 kg/m - 10 BARRAS POR PACOTE

BARCO

BORDA NORMAL

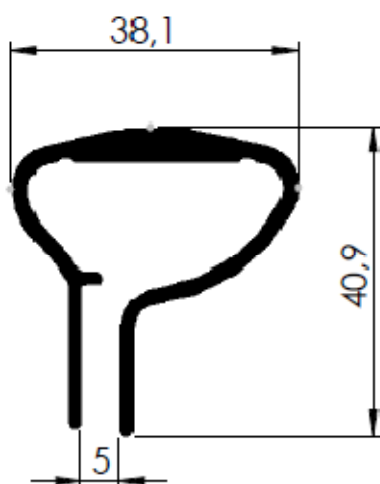

601280001 - PESO 0,906 kg/m
6 BARRAS POR PACOTE

BORDA LEVE

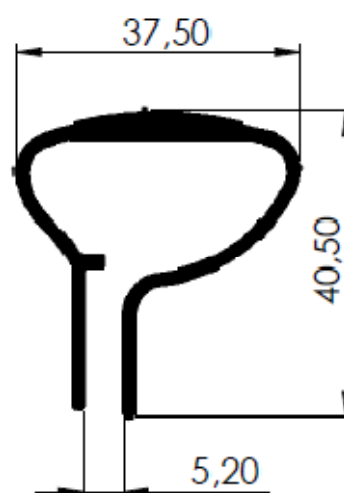

601280005 - PESO 0,669 kg/m
8 BARRAS POR PACOTE

FLUTUANTE

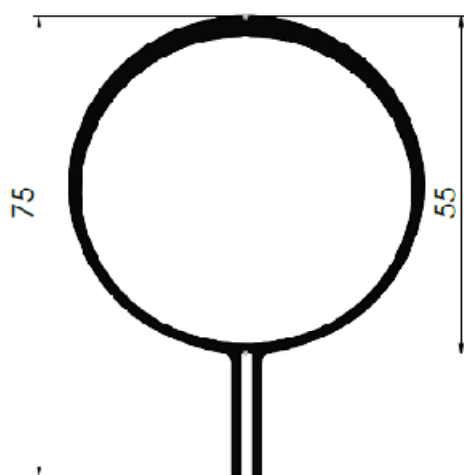

601280011 - PESO 1,209 kg/m
4 BARRAS POR PACOTE

PERFIL "T"

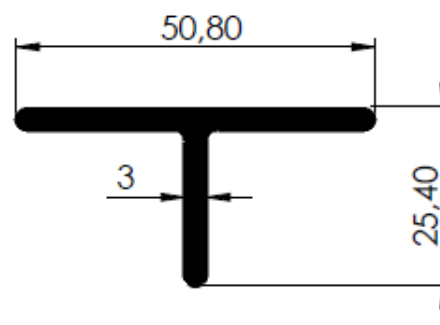

601280003 - PESO 0,638 kg/m
9 BARRAS POR PACOTE

BARCO

TRAPÉZIO LEVE

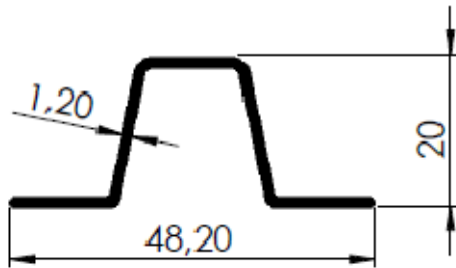

601280004 - PESO 0,265 kg/m
20 BARRAS POR PACOTE

TRAPÉZIO NORMAL

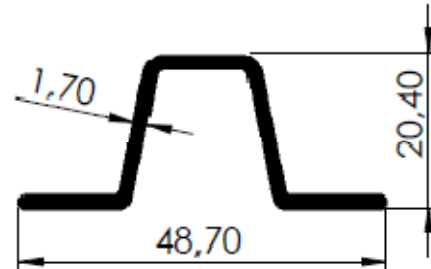

601280002 - PESO 0,375 kg/m
12 BARRAS POR PACOTE

TRAPÉZIO NOVO

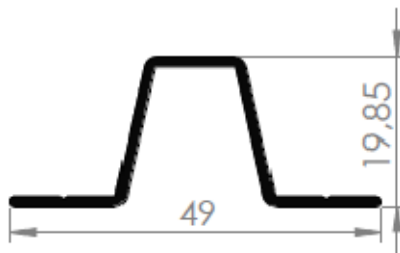

601280008 - PESO 0,305 kg/m
20 BARRAS POR PACOTE

TRAPÉZIO 4

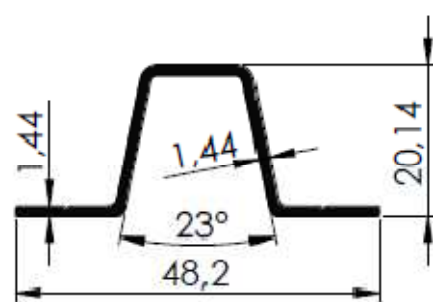

601280009 - PESO 0,316 kg/m
20 BARRAS POR PACOTE

TRAPÉZIO 61 X 32,5

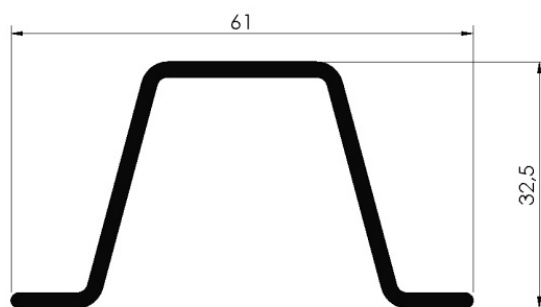

601280015 - PESO 0,596 kg/m
6 BARRAS POR PACOTE

QUILHA

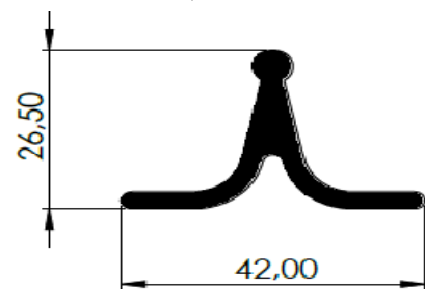

601280021 - PESO 0,627 kg/m
8 BARRAS POR PACOTE

ARO PARA BICICLETA

BIVALENTE

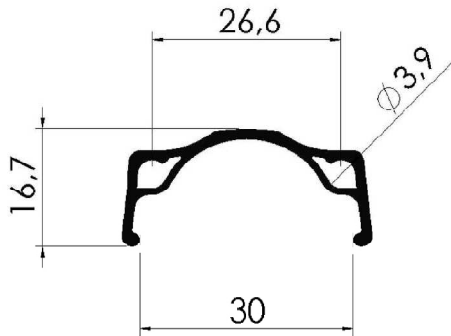

601138553 - PESO 0,304 kg/m

20 BARRAS POR PACOTE

AERO ENDURO II

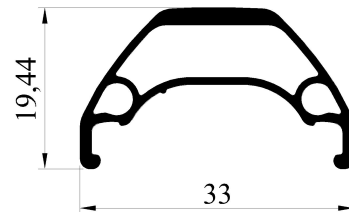

601130140 - PESO 0,330 kg/m

15 BARRAS POR PACOTE

AERO

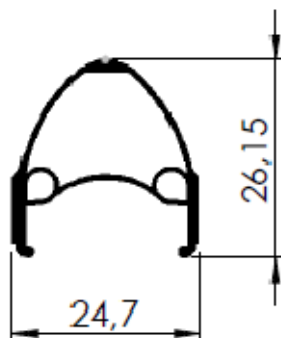

601130862 - PESO 0,283 kg/m

20 BARRAS POR PACOTE

AERO MAXIMUM

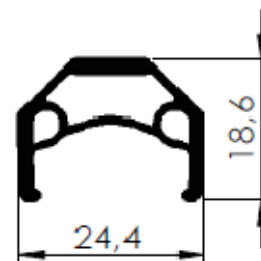

601130011 - PESO 0,293 kg/m

20 BARRAS POR PACOTE

AEREO TUBELESS

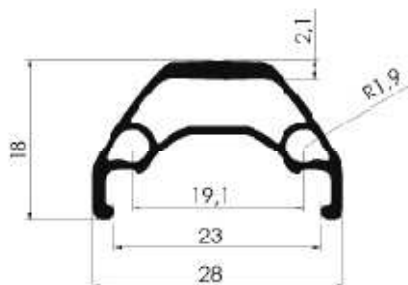

601130123 - PESO 0,292 kg/m

20 BARRAS POR PACOTE

VEMAX II

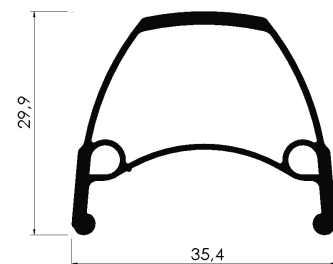

601130122 - PESO 0,404kg/m

15 BARRAS POR PACOTE

ARO PARA BICICLETA

CONVENCIONAL LEVE

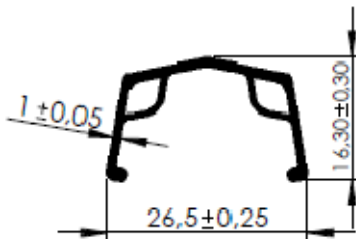

601130872 - PESO 0,198 kg/m
20 BARRAS POR PACOTE

CONVENCIONAL REFORÇADO

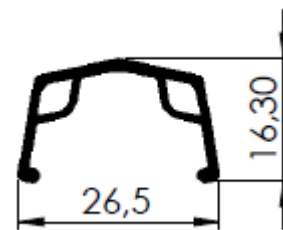

601138672 PESO 0,231 kg/m
20 BARRAS POR PACOTE

CONVENCIONAL MAX

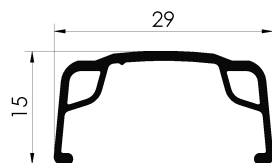

601130105 - PESO 0,207 kg/m
20 BARRAS POR PACOTE

BARRA FORTE REFORÇADO

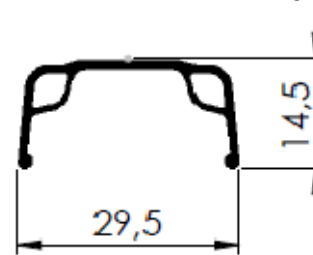

601130861 - PESO 0,235 kg/m
20 BARRAS POR PACOTE

CAMINHÃO – TRILHOS PARA CABINES

TRILHO I ESPECIAL

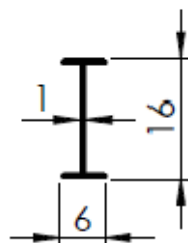

600030003- PESO 0,075 kg/m
5 ROLOS (5,5m OU 7m) POR PACOTE
20 BRS PACOTE P/ 6M (300 QUILOS)

TRILHO C

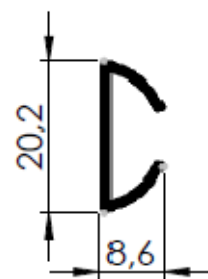

600030002 PESO 0,168 kg/m
0,355 kg BARRA 2,05 m
6 BARRAS POR PACOTE

CAMINHÃO – PROTEÇÃO LATERAL

ARREMATE TRASEIRO COMERCIAL

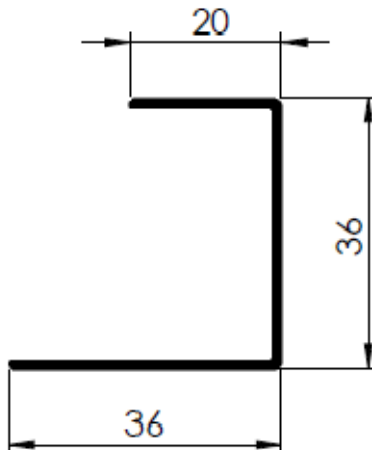

601271005 - PESO 0,378 kg/m
3 BARRAS POR PACOTE

ARREMATE TRASEIRO COMERCIAL (NOVO)

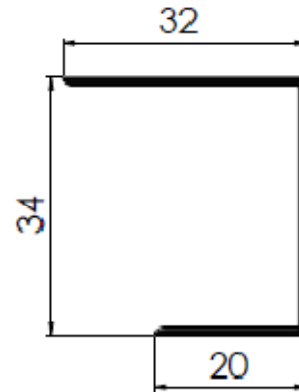

601270005 - PESO 0,249 kg/m
3 BARRAS POR PACOTE

ARREMATE DIANTEIRO COMERCIAL

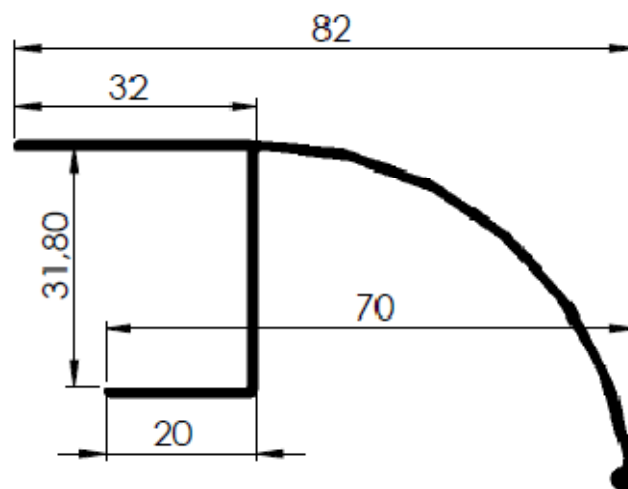

601271006 PESO 0,506 kg/m - 3 BARRAS POR PACOTE

CAMINHÃO – PROTEÇÃO LATERAL

ARREMATE DIANTEIRO COMERCIAL (NOVO)

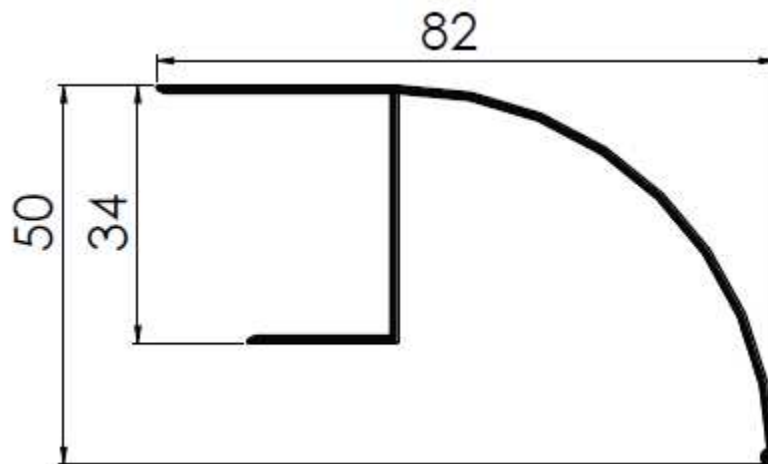

601270006 PESO 0,484 kg/m - 3 BARRAS POR PACOTE

CAMINHÃO – PROTEÇÃO LATERAL

TRAVESSA LATERAL COMERCIAL VI

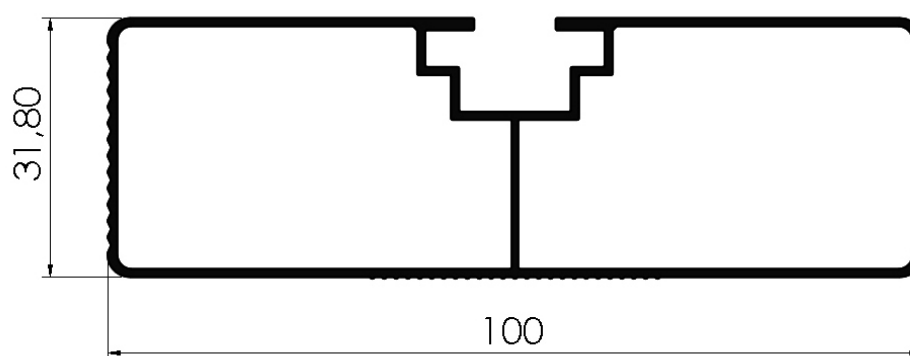

601270025 - PESO 0,837 kg/m 3 BARRAS POR PACOTE

CAMINHÃO – PROTEÇÃO LATERAL

TRAVESSA LATERAL "COMERCIAL III"

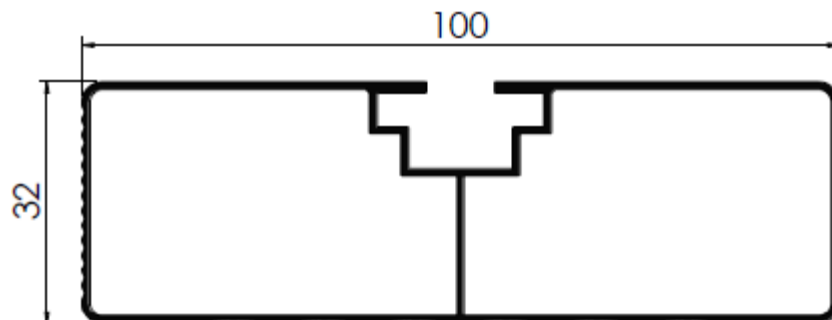

601270004 - PESO 0,837 kg/m - 3 BARRAS POR PACOTE

TRAVESSA LATERAL "COMERCIAL IV"

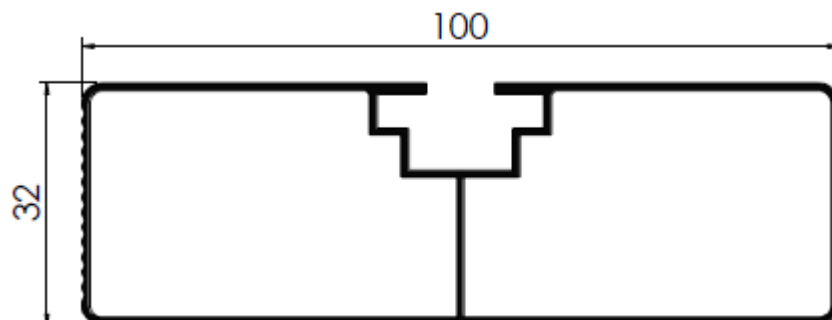

601270015 - PESO 0,966 kg/m - 3 BARRAS POR PACOTE

TRAVESSA LATERAL V

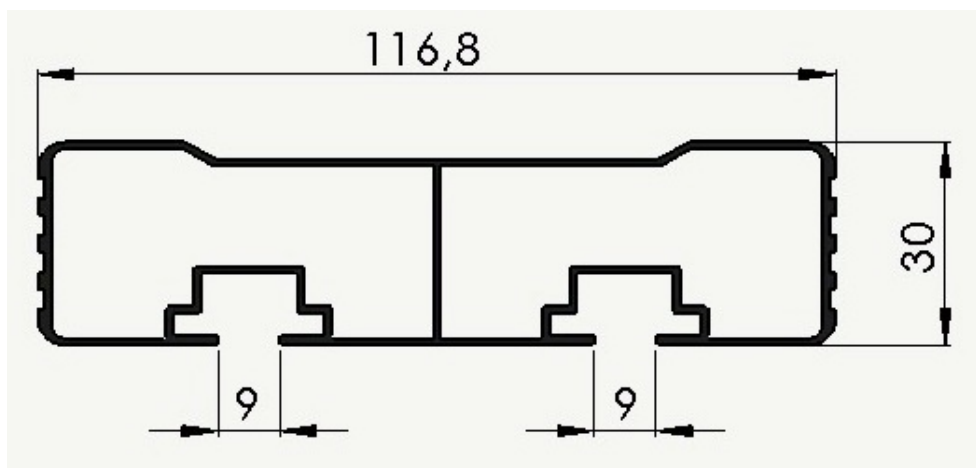

601270022 - PESO 1,179 kg/m - 3 BARRAS POR PACOTE

CAMINHÃO – PROTEÇÃO LATERAL

TRAVESSA LATERAL "COMERCIAL II"

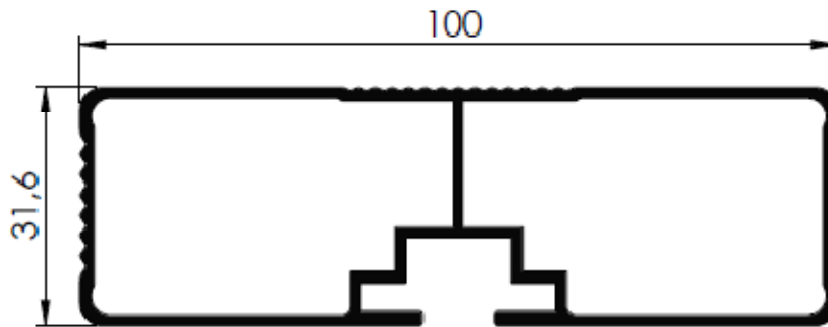

601270002 - PESO 1,198 kg/m - 3 BARRAS POR PACOTE

TRAVESSA LATERAL T-3687

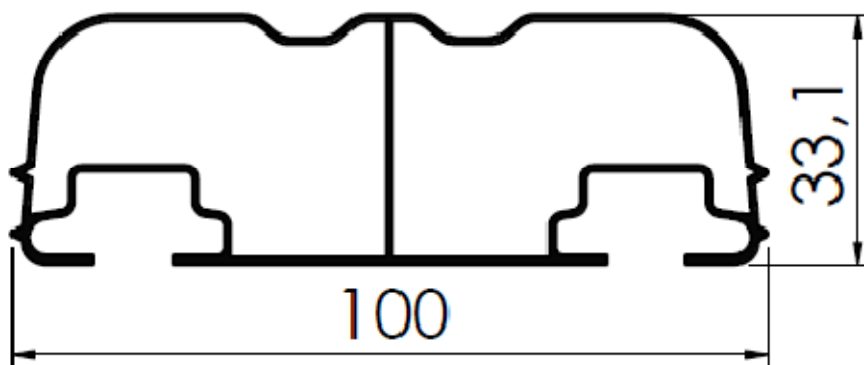

601270008 - PESO 0,943 kg/m - 3 BARRAS POR PACOTE

PROTETOR LATERAL BOIADEIRA

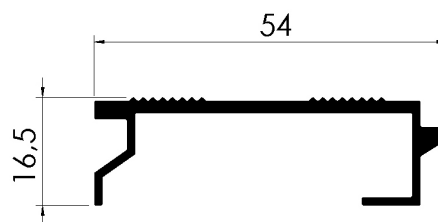

601270013 PESO 0,480 kg/m - 3 BARRAS POR PACOTE

CAMINHÃO – PROTEÇÃO LATERAL

TRAVESSA LATERAL COMERCIAL

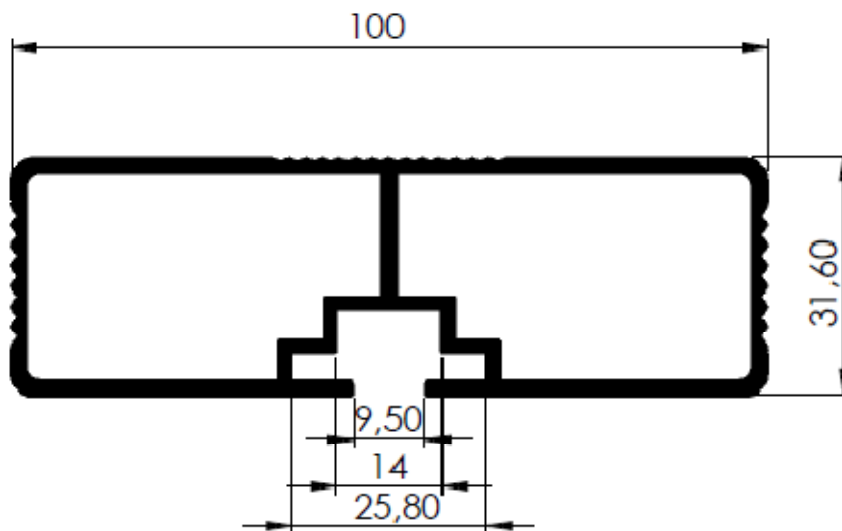

601271004 - PESO 1,598 kg/m 3 BARRAS POR PACOTE

TRAVESSA LATERAL "NOVA"

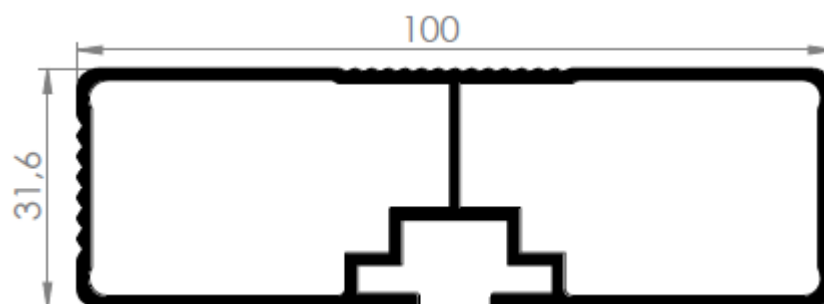

601270001 PESO 1,380 kg/m 3 BARRAS POR PACOTE

CAMINHÃO – DIVERSOS

ESTICADOR DE LONA SIDER

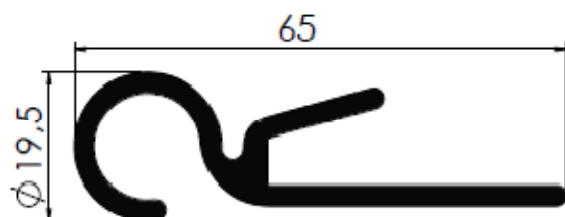

601270012 - PESO 0,712 kg/m
4 BARRAS POR PACOTE

ENGATE PARA LONA

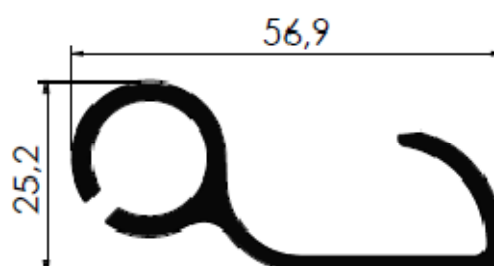

601270007 - PESO 0,830 kg/m
6 BARRAS POR PACOTE

ENROLADOR LONA SIDER

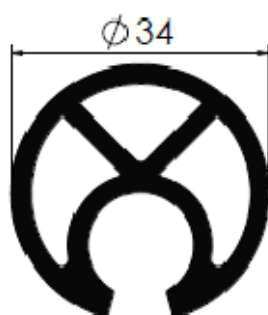

601270011 - PESO 1,122 kg/m
3 BARRAS POR PACOTE

PERFIL "J" BAÚ



601270013 - PESO 0,128 kg/m
10 BARRAS POR PACOTE

PERFIL "J" BAÚ II

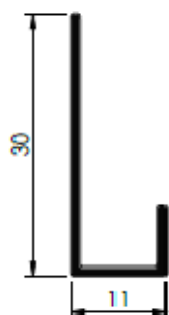

601270021 - PESO 0,134 kg/m
10 BARRAS POR PACOTE

PERFIL "J" BAÚ III

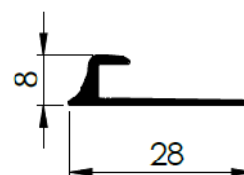

601270024 - PESO 0,1178 kg/m
10 BARRAS POR PACOTE

CAMINHÃO – DIVERSOS

CANTONEIRA BAU III

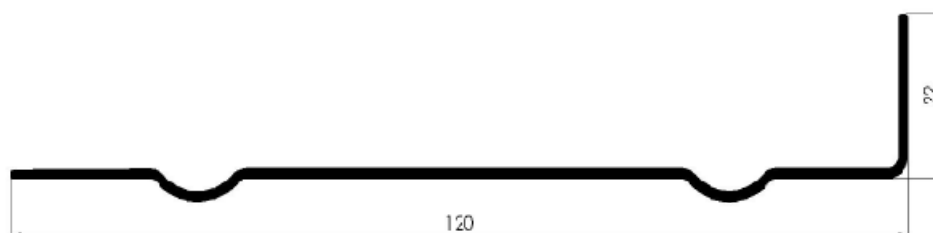

601270019 - PESO 0,565 kg/m
6 BARRAS POR PACOTE

CANTONEIRA BAU II

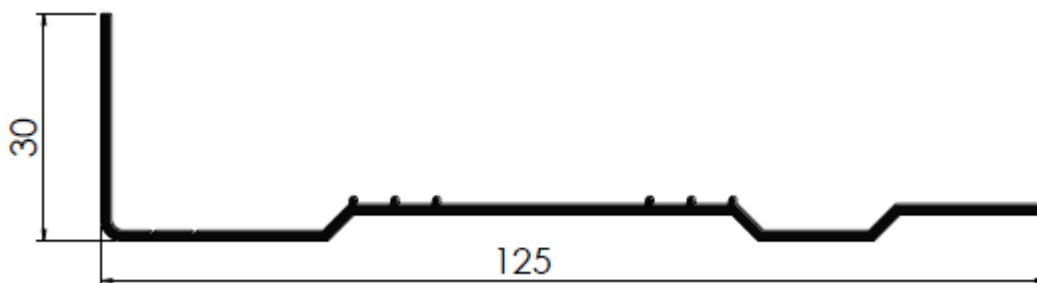

601270014 - PESO 0,639 kg/m
4 BARRAS POR PACOTE

CANTONEIRA BAU (BARRANQUEIRA)

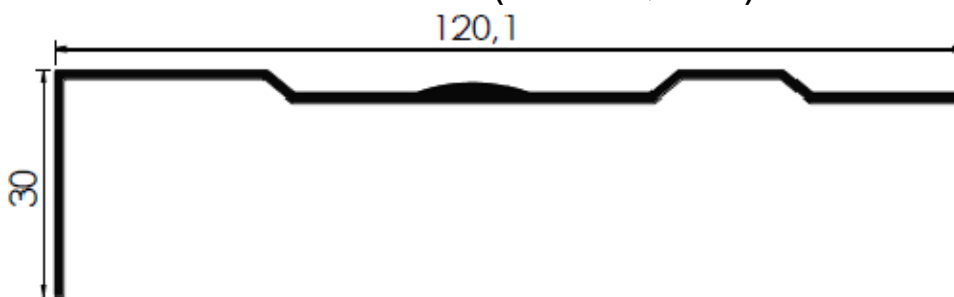

601270009 - PESO 0,528 kg/m
4 BARRAS POR PACOTE

GUIA PARA PALET

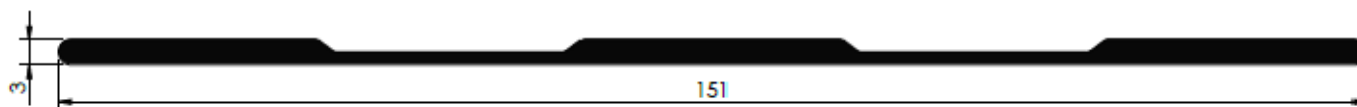

601270020 - PESO 0,970 kg/m
3 BARRAS POR PACOTE

CAMINHÃO – DIVERSOS

GANCHEIRA PARA FURGÃO FIGRORÍFICO

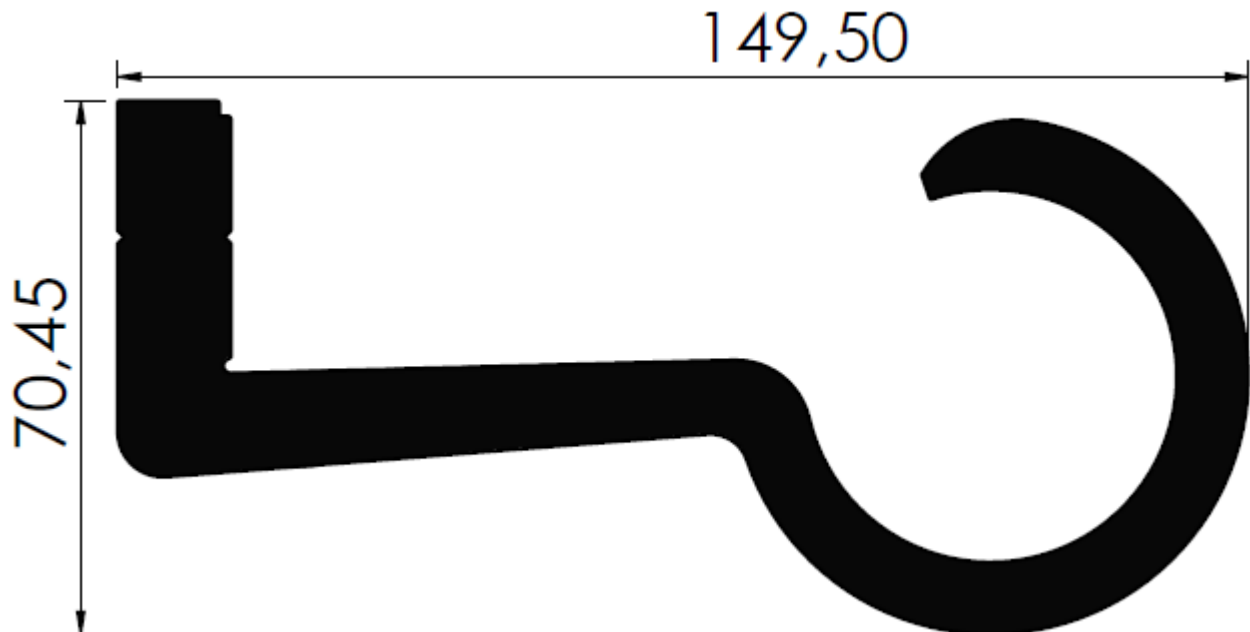

601270010 - PESO 7,930 kg/m

1 BARRAS COM 1,5 POR PACOTE

DISPONIBILIZAMOS PEÇAS ACABADAS COM 60MM - USINADAS E POLIDAS - CAIXA COM 12 UNIDADES

BATENTE PARA FURGÃO

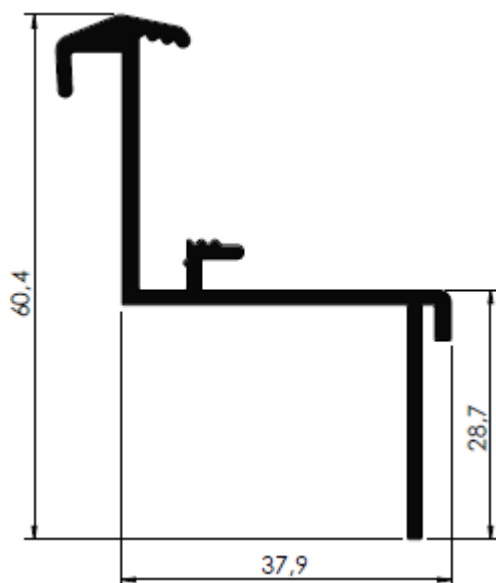

601270016 - PESO 7,930 kg/m

6 BARRAS POR PACOTE

ANTIDERRAPANTE P/ PARA-CHOQUE



601270003 - PESO 0,421 kg/m

10 BARRAS POR PACOTE

CAMINHÃO – TIRA FINA

TRITUB. COM. NOVA*

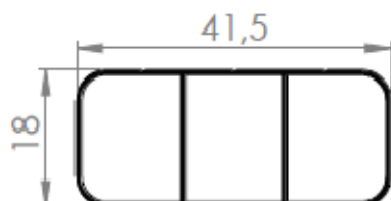

600050004 - PESO 0,263 kg/m
10 BARRAS POR PACOTE

OBLONGA TRITUB. COM. NOVA*

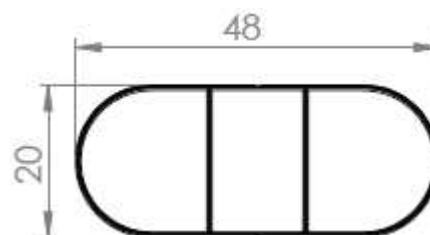

600050005 - PESO 0,296 kg/m
10 BARRAS POR PACOTE

TRITUB. COM CAVAS NOVA

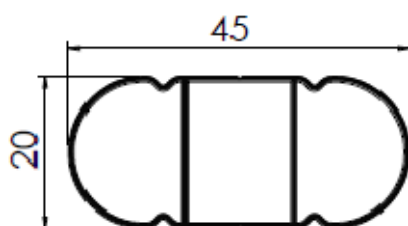

600050006 - PESO 0,320 kg/m
10 BARRAS POR PACOTE

(*) **COMERCIALIZAMOS A TAMPA PLÁSTICA PARA ESTE MODELO**

LINHA FOTOVOLTAÍCO

ESTRUTURAL FOTOVOLTAICO

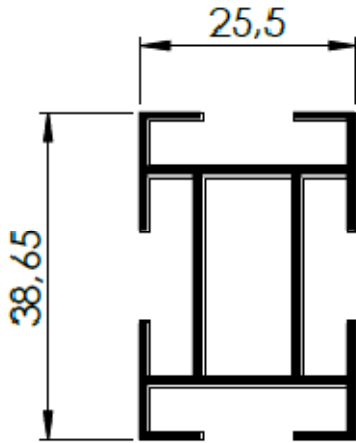

601260021 - PESO 0,600 kg/m
8 BARRAS POR PACOTE

PRESILHA DE FIXAÇÃO PAINEL SOLAR

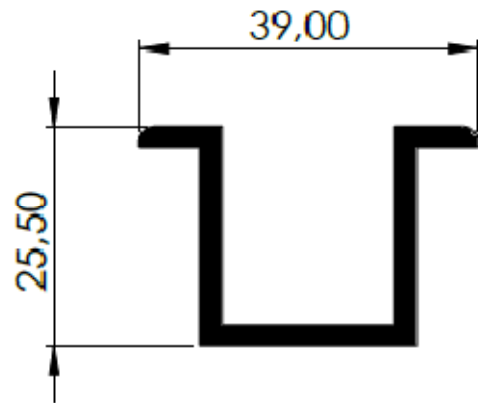

601260022 - PESO 0,600 kg/m
8 BARRAS POR PACOTE

PERFIL FOTOVOLTAICO NH-021

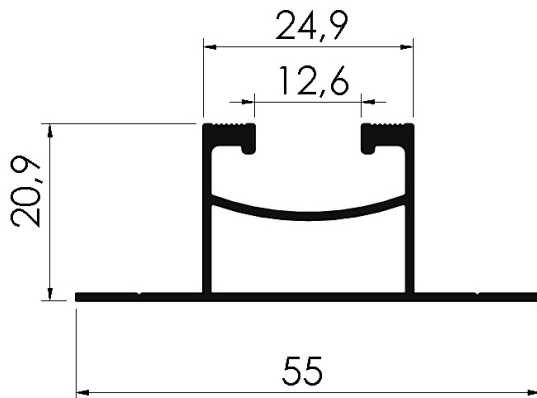

601260023 - PESO 0,383 kg/m
10 BARRAS POR PACOTE

PERFIL FOTOVOLTAICO NH-022

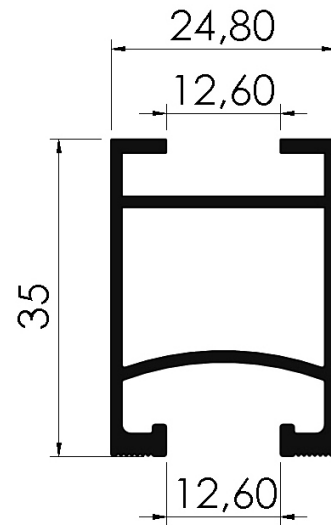

601260024 - PESO 0,510 kg/m
8 BARRAS POR PACOTE

TERMINAL DE PLACA SOLAR

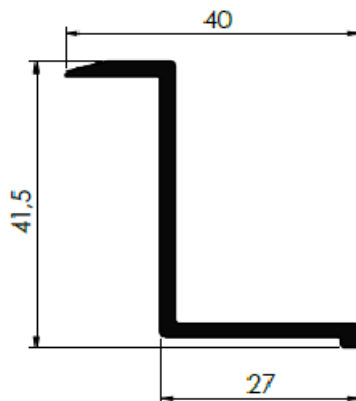

601260017 - PESO 0,441 kg/m
12 BARRAS POR PACOTE

LINHA CASE

CASE 01 31,4 X 13,9MM

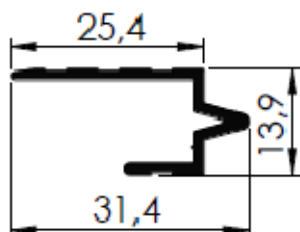

601130073 PESO 0,198 kg/m
30 BARRAS POR PACOTE

CASE 02 25,4 X 13,9MM

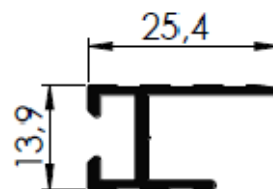

601130074 - PESO 0,221 kg/m
20 BARRAS POR PACOTE

CASE 03 18,9 X 18,9MM

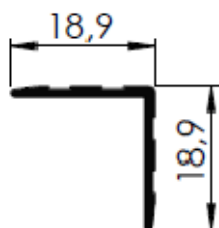

601130075 - PESO 0,123 kg/m
40 BARRAS POR PACOTE

CASE 04 25,4 X 25,4MM

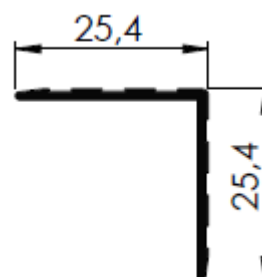

601130076 - PESO 0,167 kg/m
30 BARRAS POR PACOTE

CASE 05 22,5 X 18,8MM

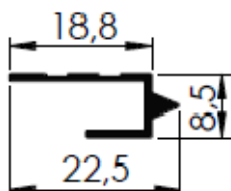

601130080 - PESO 0,112 kg/m
40 BARRAS POR PACOTE

CASE 06 17,9 X 12,4MM

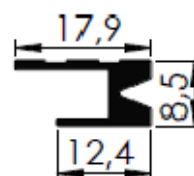

601130081 - PESO 0,155 kg/m
30 BARRAS POR PACOTE

MOVELEIRA

OBLONGO 37,7 x 15,5 x 1,0MM

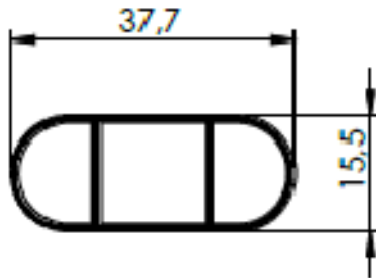

601080014 - PESO 0,334 kg/m
10 BARRAS POR PACOTE

OBLONGO 38,7 x 15,5 x 1,0MM

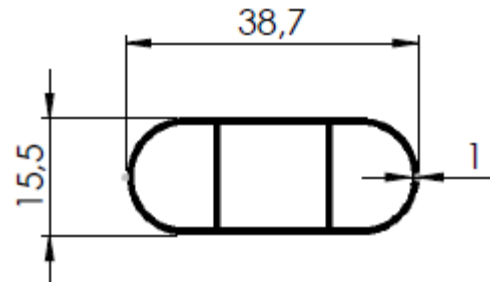

601080002 - PESO 0,326 kg/m
10 BARRAS POR PACOTE

OBLONGO 38,7 x 15,5 x 1,05MM

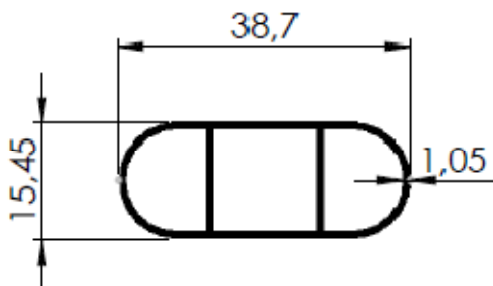

601088784 - PESO 0,351 kg/m
10 BARRAS POR PACOTE

OBLONGO 38,7 x 15,5 x 1,2MM

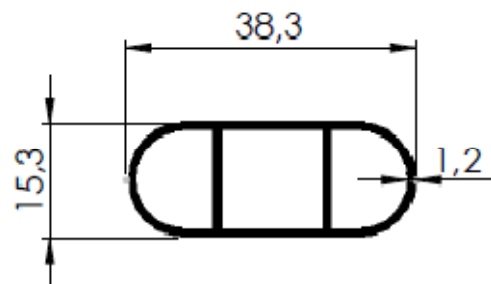

601088782 - PESO 0,396 kg/m
10 BARRAS POR PACOTE

OBLONGO 38,7 x 15,5 x 1,6MM

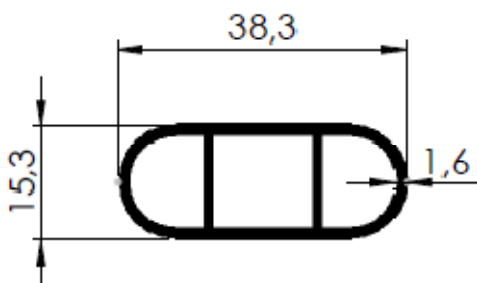

601082910 - PESO 0,494 kg/m
10 BARRAS POR PACOTE

OBLONGO 49,8 x 15 x 1,15MM

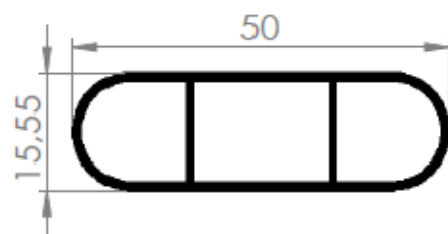

601080009 PESO 0,442 kg/m
10 BARRAS POR PACOTE

MOVELEIRA

OBLONGO 50 x 15 x 1,4 X 1,4MM

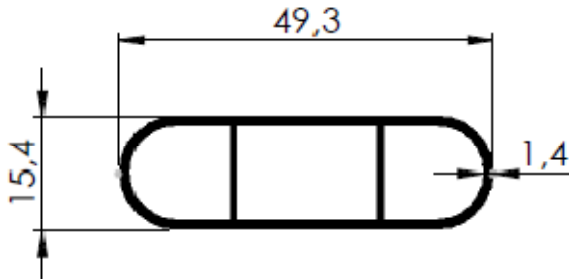

601088785 - PESO 0,514 kg/m
10 BARRAS POR PACOTE

TRAV. BITULAR 60 x 7 x 1,2MM

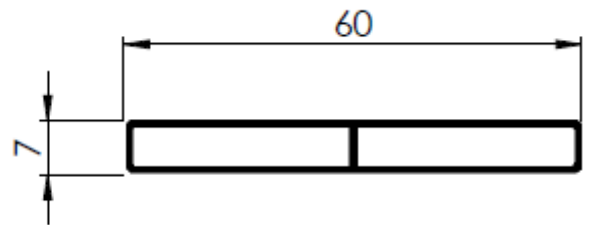

601071591 - PESO 0,384 kg/m
10 BARRAS POR PACOTE

TRAVA TELA 25 X 20 X 1,5MM

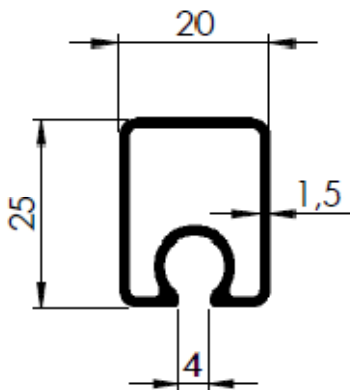

601140521 PESO 0,430 kg/m
10 BARRAS POR PACOTE

ELIPTICO 35 X 20 X 1,3MM C/ ALMA

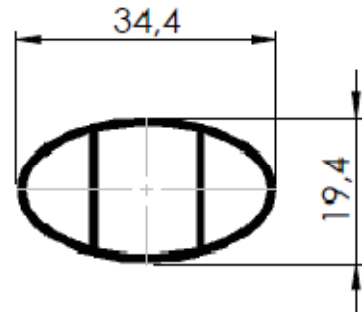

601110006 - PESO 0,388 kg/m
10 BARRAS POR PACOTE

ELIPTICO 45 X 20 X 1,6MM C/ ALMA

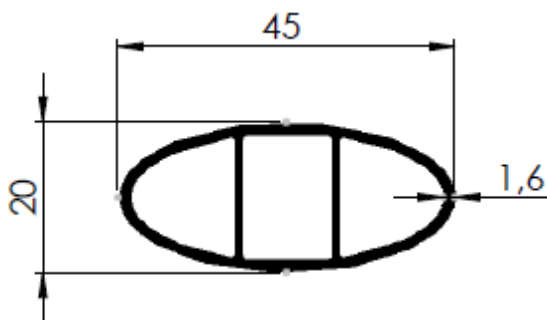

601110005 PESO 0,544 kg/m
10 BARRAS POR PACOTE

OBLONGO C/ ABA 49 X 17 X 11,4MM

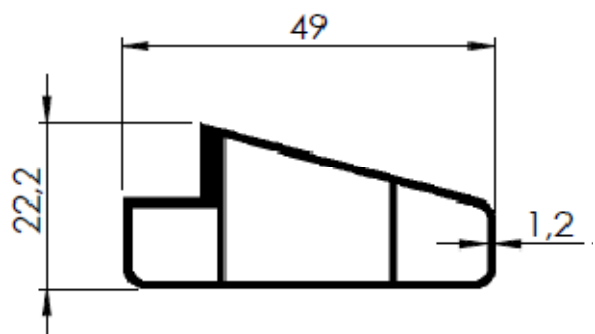

601080001 - PESO 0,546 kg/m
10 BARRAS POR PACOTE

MOVELEIRA

TRAV. BITUBULAR 42 X 18 X 1,2MM

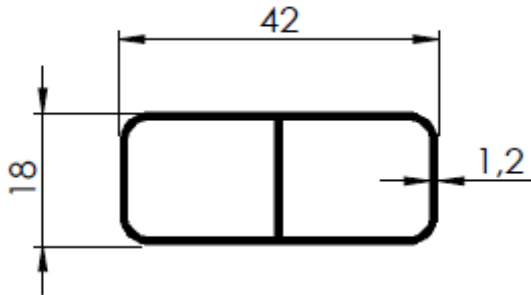

601071592 - PESO 0,415 kg/m
10 BARRAS POR PACOTE

TRAV. BITUBULAR 42 X 18 X 1,7MM

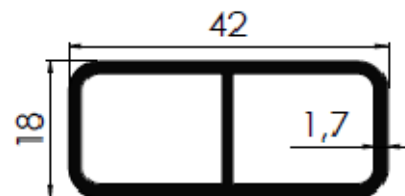

601070011 - PESO 0,579 kg/m
10 BARRAS POR PACOTE

TRAV. TRITUBULAR 38 X 16,50MM

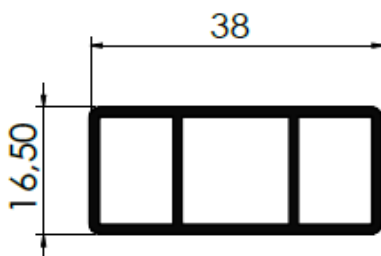

601070015 - PESO 0,473 kg/m
10 BARRAS POR PACOTE

TRAVESSA 49,8 X 14 X 1.2MM

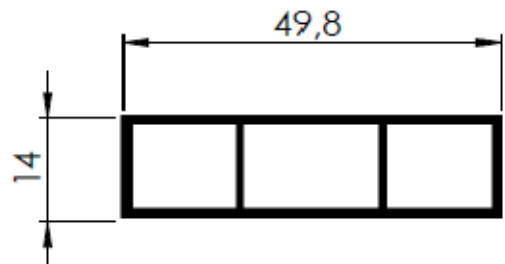

601138673 - PESO 0,498 kg/m
10 BARRAS POR PACOTE

**TRAV. TRITUBULAR C/ FRISO EXT.
42,4 X 18,0 X 0,94MM**

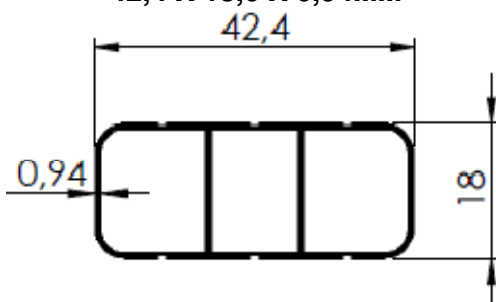

600051109 - PESO 0,378 kg/m
10 BARRAS POR PACOTE

MOVELEIRA

TRAV. TRITUBULAR 35X16,8X1,6MM

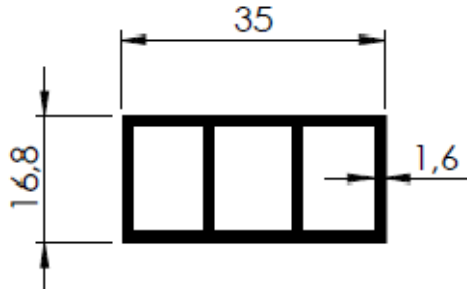

601131557 - PESO 0,567 kg/m
10 BARRAS POR PACOTE

PERFIL P/ TELA MOSQUITEIRA

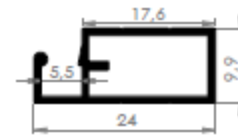

601130043 - PESO 0,182 kg/m
30 BARRAS POR PACOTE

PERFIL BITUBULAR "REGUA FINA"

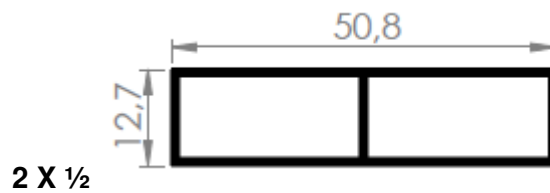

600020012 - PESADA SEM TAMPA - LINHA MOVELERIA
PESO 0,382 kg/m 10 BARRAS POR PACOTE

PERFIL BITUBULAR 3 X 1

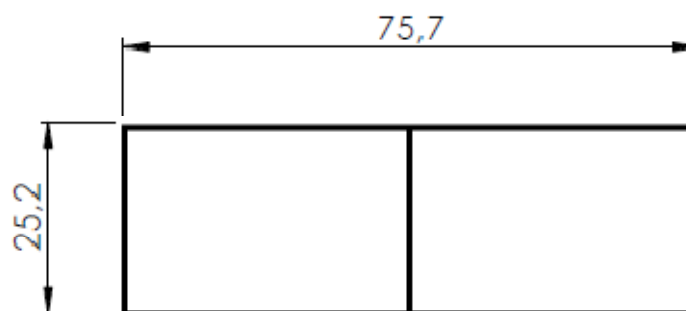

601070005 - PESADA SEM TAMPA - LINHA MOVELERIA
PESO 0,924 kg/m - 6 BARRAS POR PACOTE

MOVELEIRA

TUBO QUADRADO PENTATUBULAR

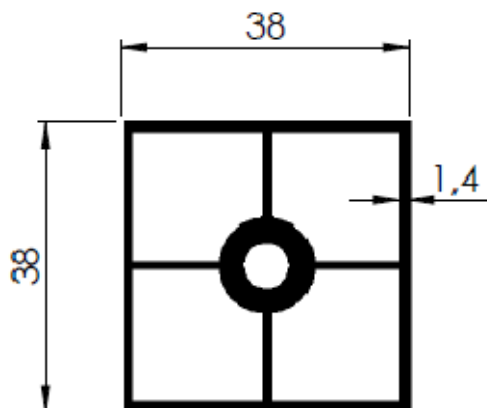

601140001 - PESO 1,022 kg/m
6 BARRAS POR PACOTE

TUBO REDONDO 38,10 COM OLHAL

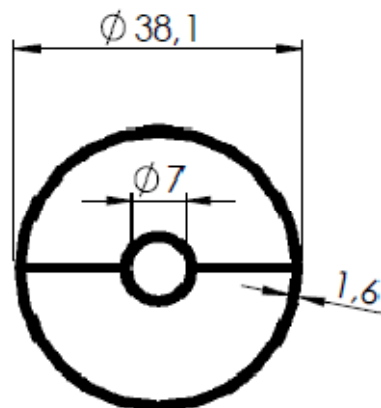

601140004 - PESO 0,735 kg/m
6 BARRAS POR PACOTE

**TUBO QUAD. 3/4" X 1MM
C/ OLHAL**

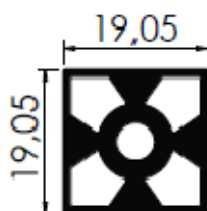

601140027 - PESO 0,558 kg/m
8 BARRAS POR PACOTE

**TUBO RETANGULAR (FRISO INTERNO)
50,8 X 38,1 X 0,95**

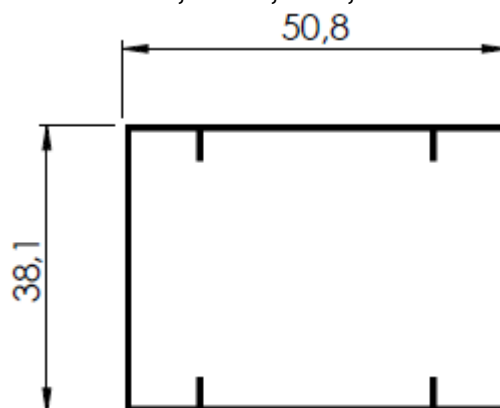

601070004 - PESO 0,530 kg/m
6 BARRAS POR PACOTE

PERFIL LATERAL MESA 30 X 12,5 MM

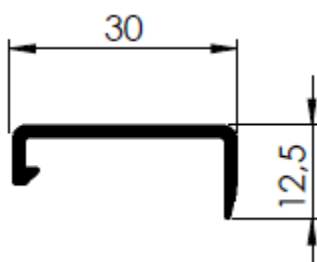

601130016 - PESO 0,273 kg/m
20 BARRAS POR PACOTE

PERFIL LATERAL MESA 39 X 14,5MM

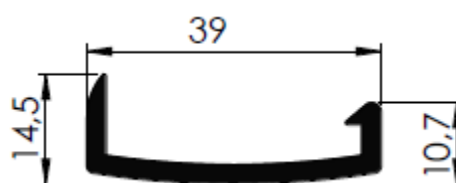

601130086 - PESO 0,409 kg/m
10 BARRAS POR PACOTE

MOVELEIRA

TRILHO INF. MONO 20,8 X 6MM



601140003 - PESO 0,067 kg/m
30 BARRAS POR PACOTE

TRILHO INFERIOR 36,70 X 5,10MM

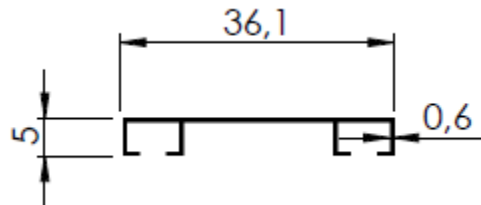

601140515 - PESO 0,103 kg/m
30 BARRAS POR PACOTE

TRILHO INFERIOR 38,5 X 8MM

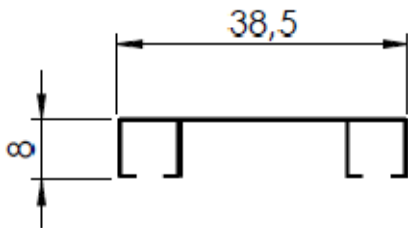

601140005 - PESO 0,147 kg/m
30 BARRAS POR PACOTE

TRILHO INFERIOR 42 X 5,30MM

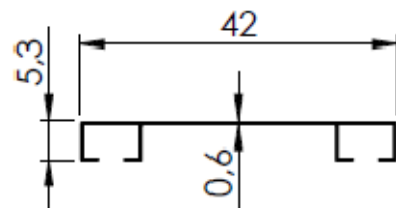

601140519 - PESO 0,117 kg/m
30 BARRAS POR PACOTE

TRILHO INFERIOR 46 X 5,7MMX0,7MM

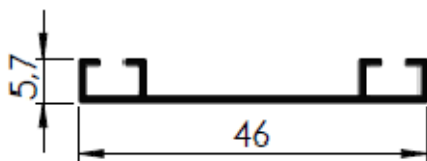

601140012 - PESO 0,147 kg/m
30 BARRAS POR PACOTE

TRILHO INFERIOR 47,1 X 5,7 X 0,7MM

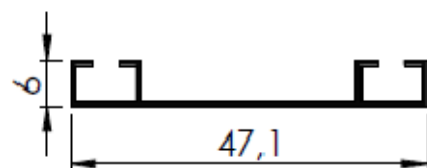

601140017 - PESO 0,154 kg/m
30 BARRAS POR PACOTE

MOVELEIRA

TRILHO INFERIOR 46 X 5,7MMX0,7MM

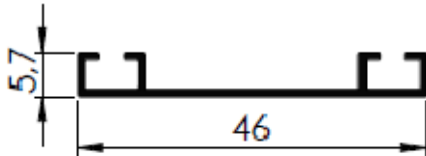

601140012 - PESO 0,147 kg/m
30 BARRAS POR PACOTE

TRILHO INFERIOR 47,1 X 5,7 X 0,7MM

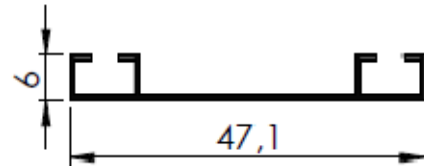

601140017 - PESO 0,154 kg/m
30 BARRAS POR PACOTE

PUXADOR 38 X 17,2MM MV-15

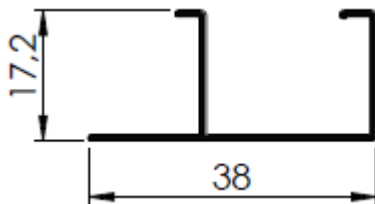

601140011 - PESO 0,170 kg/m
30 BARRAS POR PACOTE

MOLDURA DE ESPELHO

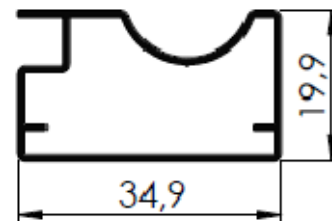

601130085 - PESO 0,314 kg/m
10 BARRAS POR PACOTE

PUXADOR 32,5 X 17,5MM

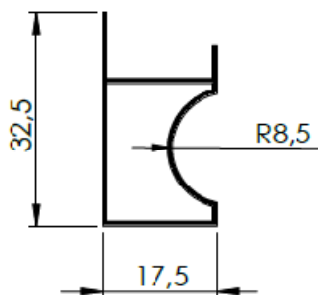

601130146 - PESO 0,195 kg/m
20 BARRAS POR PACOTE

TUBO OBLONGO LISO
26,0 X 13 X 0,85

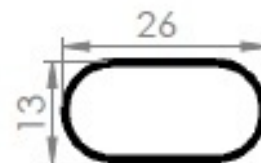

601080010 - PESO 0,155 kg/m
10 BARRAS POR PACOTE

MOVELEIRA

TUBO OBLONGO 16,5 X 12 X 1,2MM

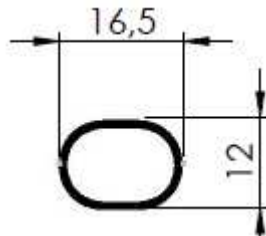

601080005 - PESO 0,146 Kg/m
30 BARRAS POR PACOTE

CABIDEIRO ESTRIADO 19 X 14,5

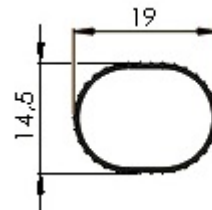

601080012 PESO 0,073 kg/m
25 BARRAS POR PACOTE

CABIDEIRO ECON. ESTR. COMERCIAL

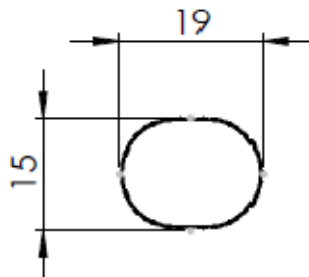

601080006 PESO 0,088 kg/m
25 BARRAS POR PACOTE

CABIDEIRO ESTRIADO 23 X 15,8

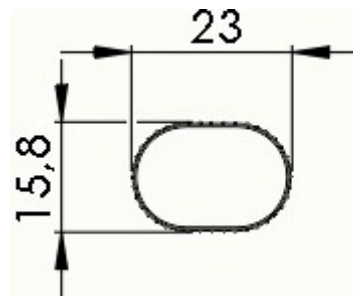

601080013 PESO 0,098 kg/m
25 BARRAS POR PACOTE

CABIDEIRO ESTRIADO LEVE 25 X 15,8

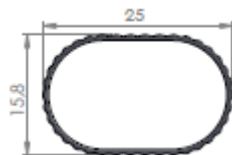

601080008 - PESO 0,101 Kg/m
25 BARRAS POR PACOTE

CABID. ESTR. COMUM COMERCIAL 26,4 X 13,3

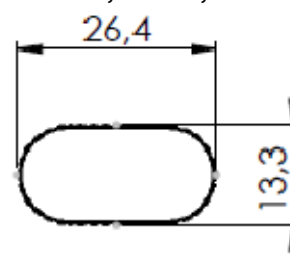

601080004 - PESO 0,116 kg/m
25 BARRAS POR PACOTE

CABIDEIRO ESTRIADO 27MM X 15MM

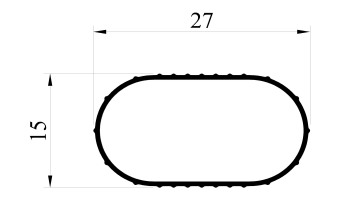

601080015 PESO 0,116 kg/m
25 BARRAS POR PACOTE

PERFIL H 17,4 X 11,6MM MV-204

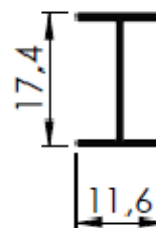

601140007 - PESO 0,075 kg/m
50 BARRAS POR PACOTE

MOVELEIRA

04 - 5%

PERFIL H 12,5 X 11MM

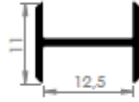

601140006 - PESO 0,087 kg/m
50 BARRAS POR PACOTE

TRILHO INFERIOR ABAS IGUAS 7,5 X 6,5MM MV-196

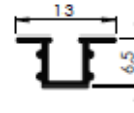

601140009 - PESO 0,049 kg/m
50 BARRAS POR PACOTE

TRILHO INFERIOR ABAS IGUAS 8,5 X 9,0MM MV-197

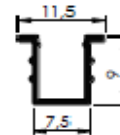

601140008 - PESO 0,058 kg/m
50 BARRAS POR PACOTE

"U" 16MMX14,3MMX0,9MM

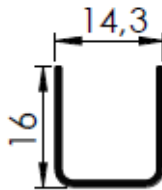

601140013 - PESO 0,111 kg/m
30 BARRAS POR PACOTE

"U" C/ ABA 16MMX14,3MM0,9MM

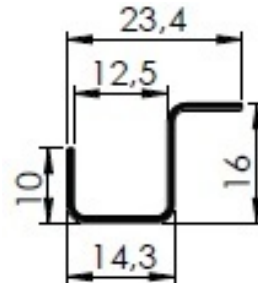

601140014 - PESO 0,116 kg/m
30 BARRAS POR PACOTE

PERFIL "U" ABAS DESIGUAIS 16,3 X 17,5MM MV-76

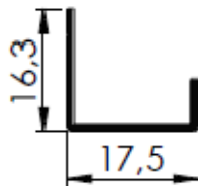

601140010 - PESO 0,099 kg/m
50 BARRAS POR PACOTE

DESEMPENO 14X15,5X4,0X0,75MM

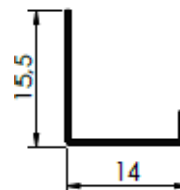

601140029 - PESO 0,067 kg/m
50 BARRAS POR PACOTE

DESEMPENO 14,9 X 10,5 X 5,2 X 1,2MM

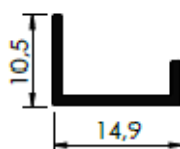

601140030 - PESO 0,096 kg/m
50 BARRAS POR PACOTE

FERRAGEM

TRILHO PARA PORTÃO

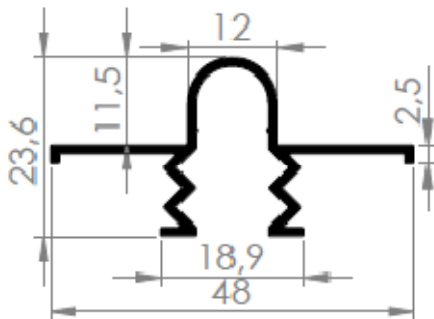

601130039 - PESO 0,346 kg/m
14 BARRAS POR PACOTE

PROLONGADOR 50,8MM

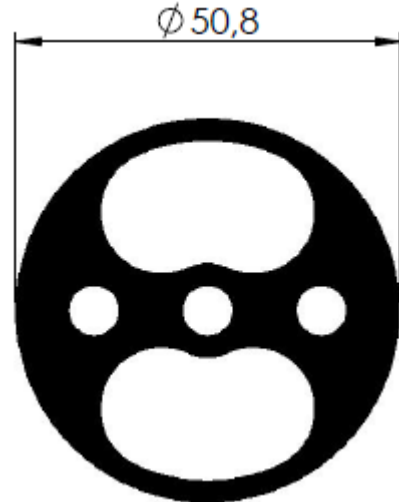

601200011 - PESO 3,170 kg/m
2 BARRA POR PACOTE

PERFIL A

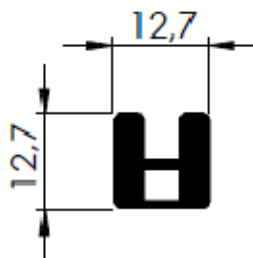

601130026 - PESO 0,324 kg/m
15 BARRAS POR PACOTE

PUXADOR QUADRADO C/ FURO

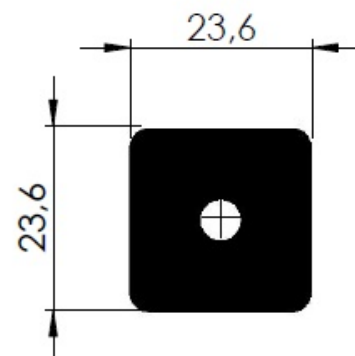

601130028 - PESO 1,507 kg/m
4 BARRAS POR PACOTE

DESCANSO DE JANELA MAX AIR

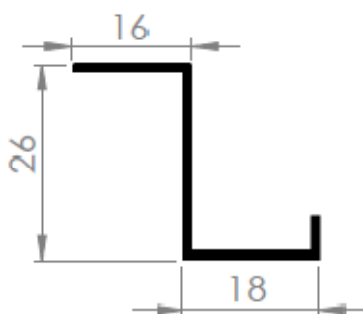

601120012 - PESO 0,228 kg/m
20 BARRAS POR PACOTE

BATENTE FECHO V. A

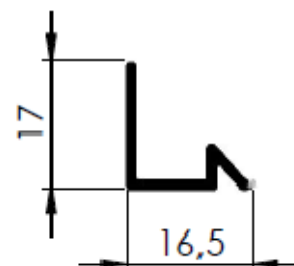

601200012 - PESO 0,161 kg/m
30 BARRAS POR PACOTE

FERRAGEM

BATENTE 73 x 2,8MM

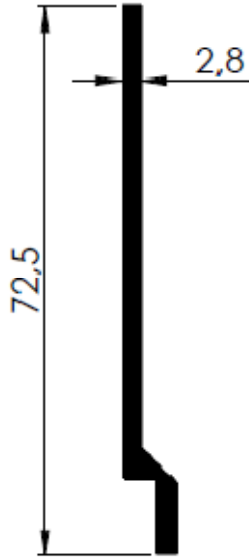

601200004 - PESO 0,604 kg/m
10 BARRAS POR PACOTE

PERFIL 1710

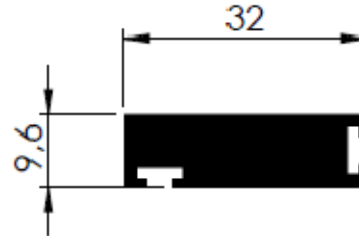

601123032 - PESO 0,802 kg/m
6 BARRAS POR PACOTE

DOBRADIÇA 32 x 3,6MM

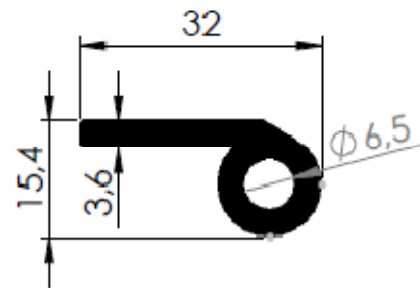

601200003 - PESO 0,578 kg/m
10 BARRAS POR PACOTE

DOBRADIÇA FURO ESTRELA 40 X 3,8MM

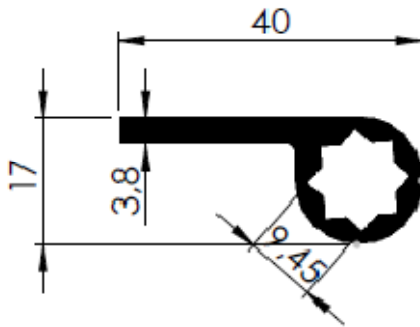

601200006 - PESO 0,639 kg/m
10 BARRAS POR PACOTE

DOBRADIÇA 51,5 x 3,7MM

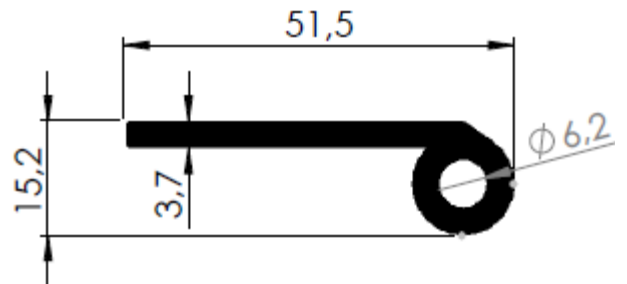

601200002 - PESO 0,788 kg/m
8 BARRAS POR PACOTE

DOBRADIÇA FURO ESTRELA 54,7 X 3,8MM

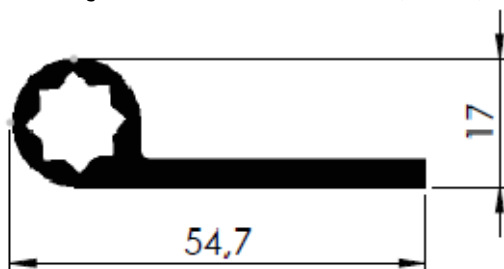

601200005 - PESO 0,796 kg/m
8 BARRAS POR PACOTE

PERFIL FERRAGEM 1531

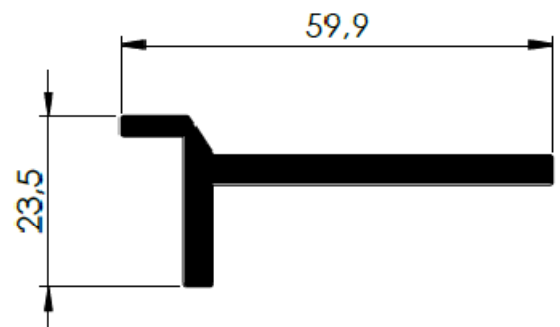

601200009 - PESO 0,864 kg/m
8 BARRAS POR PACOTE

FERRAGEM

FECHO FEMEA 50,0 x 4,4MM

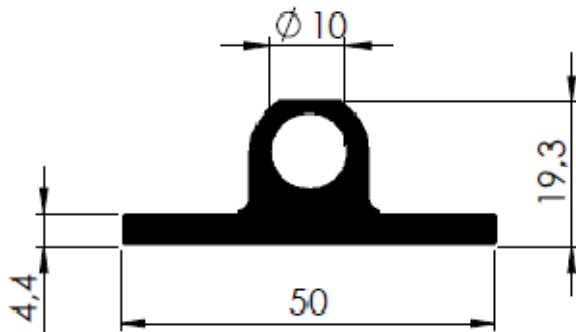

601200001 - PESO 1,034 kg/m
7 BARRAS POR PACOTE

BATE E FECHA

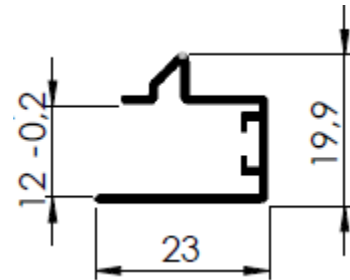

601130010 - PESO 0,238 kg/m
20 BARRAS POR PACOTE

FERRAGEM 1587 - 104,5 X 11,6MM

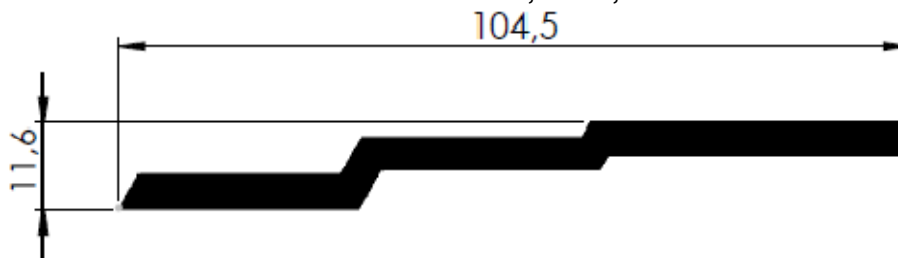

601200008 - PESO 1,400 kg/m
3 BARRAS POR PACOTE

DOBRADIÇA 100 x 4,4MM

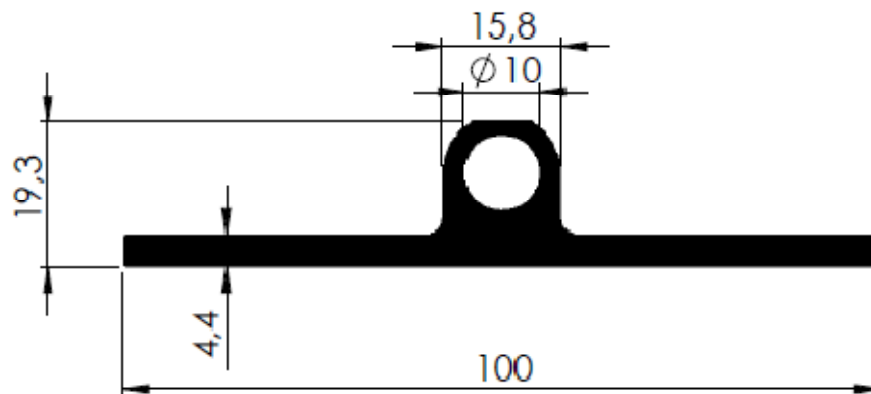

601200007 - PESO 1,659 kg/m
3 BARRAS POR PACOTE

FERRAGEM

CONTRA TRINCO 53 X 14,5MM

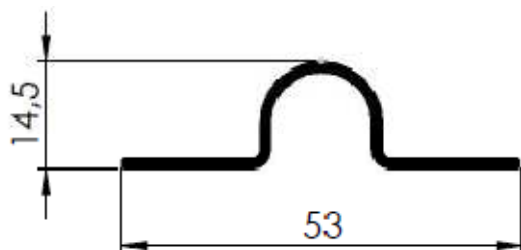

601200010 - PESO 0,320 kg/m
10 BARRAS POR PACOTE

TRINCO 56,5 X 16,5MM

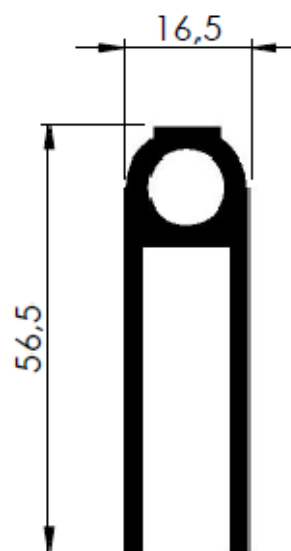

601200015 - PESO 1,024 kg/m
4 BARRAS POR PACOTE

BATE FECHA (BASE 1570)

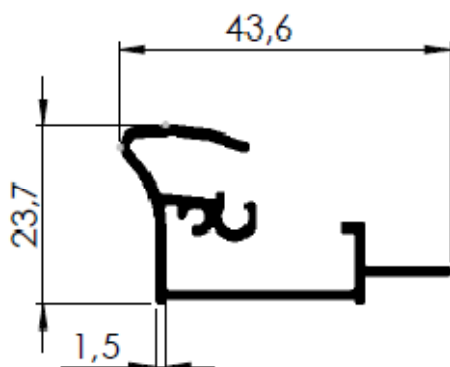

601120007 - PESO 0,457 kg/m
12 BARRAS POR PACOTE

BATE FECHA (MOVEL 1570)

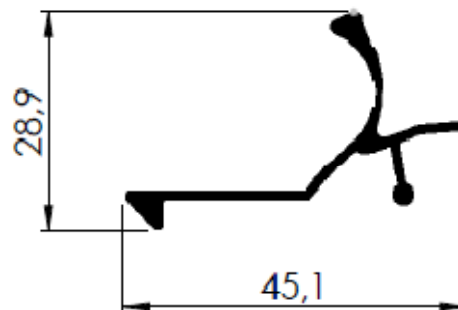

601120009 - PESO 0,359 kg/m
10 BARRAS POR PACOTE

BATE FECHA (FIXO 1570)

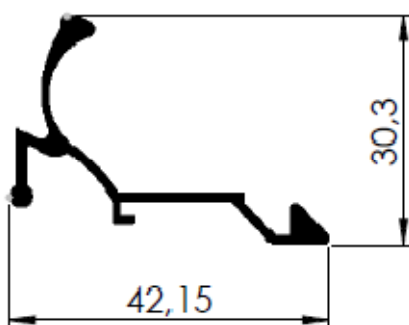

601120008 - PESO 0,373 kg/m
10 BARRAS POR PACOTE

TUBO COM GUIA 25,4 X 3 X 0,65MM



600010018 - PESO 0,828 kg/m
6 BARRAS POR PACOTE

LINHA GRADIL

NHG 083

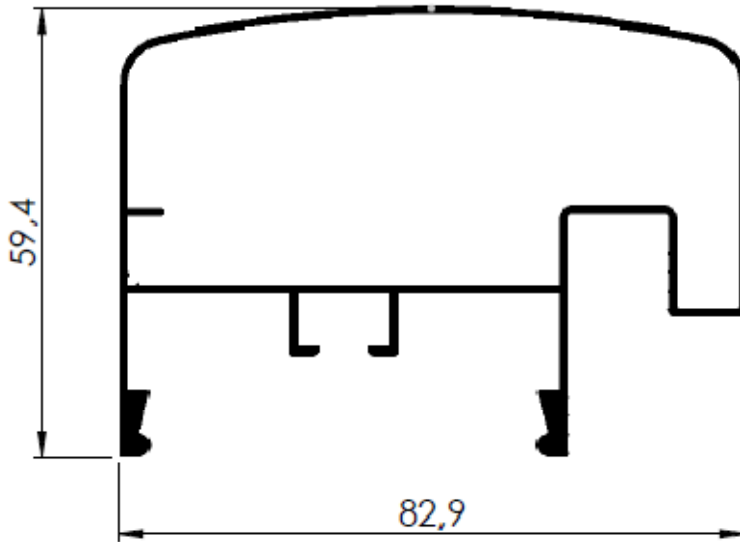

601170004 - PESO 1,240 kg/m
4 BARRAS POR PACOTE

NHG 077

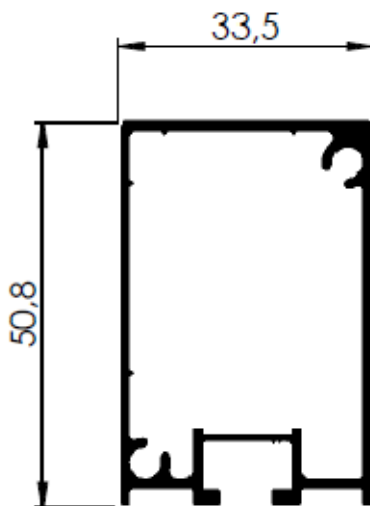

601170003 - PESO 0,838 kg/m
6 BARRAS POR PACOTE

NHG 075

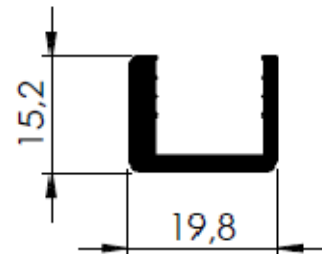

601170002 - PESO 0,331 kg/m
12 BARRAS POR PACOTE

NHG 074

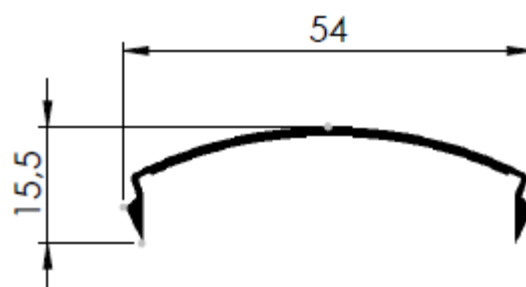

601170001 - PESO 0,258 kg/m
20 BARRAS POR PACOTE

LINHA SEGURANÇA

(*) Peso teórico, sujeito a variação de +

ou - 5%

PERFIL "C" (CERCA ELETRICA)

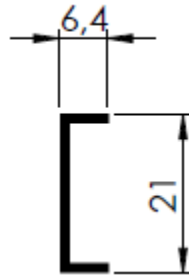

601210004 - PESO 0,119 kg/m
50 BARRAS POR PACOTE

PERFIL "M" (CERCA ELETRICA)

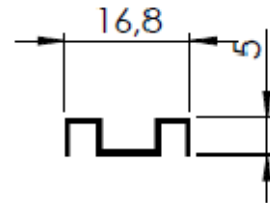

601210005 - PESO 0,076 kg/m
50 BARRAS POR PACOTE

PERFIL ESTRELA (CERCA ELÉTRICA)

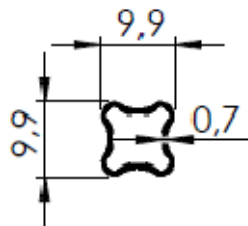

601210003 - PESO 0,089 kg/m
50 BARRAS POR PACOTE

PERFIL MEIA CANA (CERCA ELETRICA)

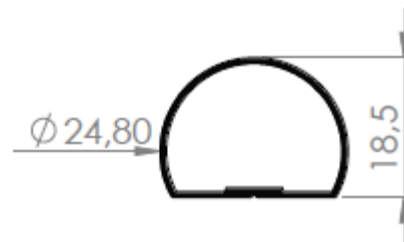

601210006 - PESO 0,170 kg/m
20 BARRAS POR PACOTE

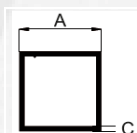

TUBOS QUADRADOS PARA CERCA ELÉTRICA

CÓDIGO	kg/m	A	C	BARRAS POR PACOTE
601060009	0,178	23,0	0,7	15
601063492	0,193	25,4	0,7	15
601060004	0,228	29,4	0,7	12
601060011	0,443	40,0	1	9

TUBO COM RELEVO

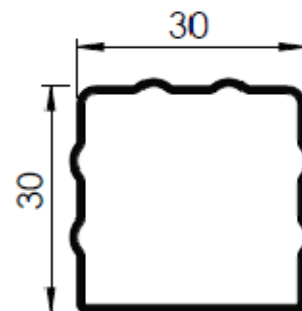

601210007 - PESO 0,302 kg/m
12 BARRAS POR PACOTE

AQUECEDOR

LATERAL PEQUENA

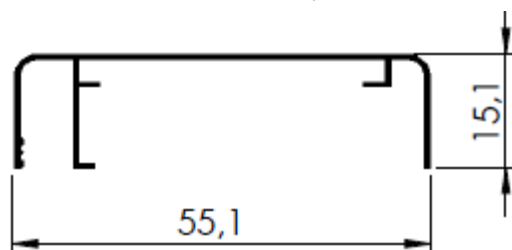

601260002 - PESO 0,257 kg/m
20 BARRAS POR PACOTE

PERFIL "T"

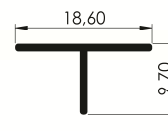

601130716 - PESO 0,066 kg/m
50 BARRAS POR PACOTE

LATERAL GRANDE

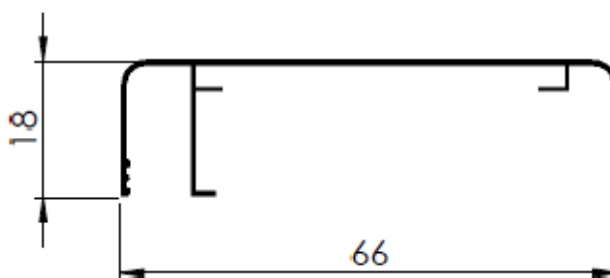

601260001 - PESO 0,278 kg/m
20 BARRAS POR PACOTE

ALETA

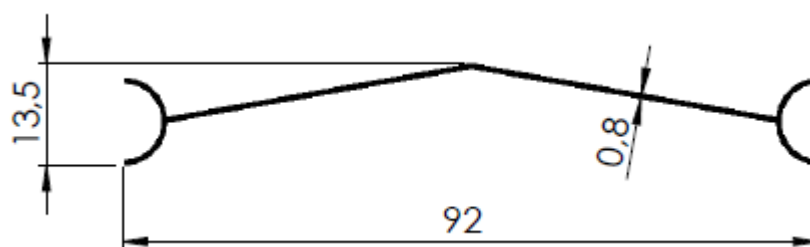

601260003 - PESO 0,263 kg/m
10 BARRAS POR PACOTE

TEMPERADO BOX 8mm

BX 059

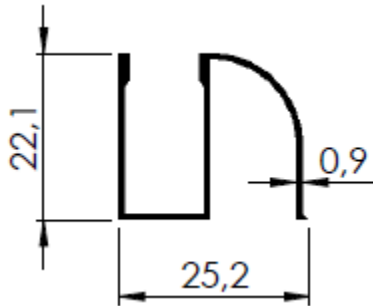

601122976 - PESO 0,221 kg/m
20 BARRAS POR PACOTE

BX 219

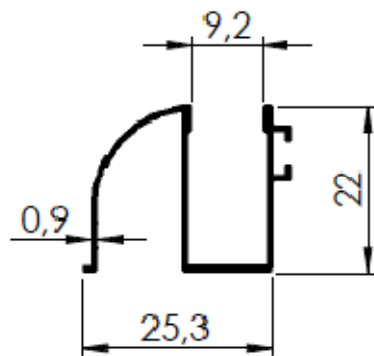

601124886 - PESO 0,245 kg/m
20 BARRAS POR PACOTE

BX 091T

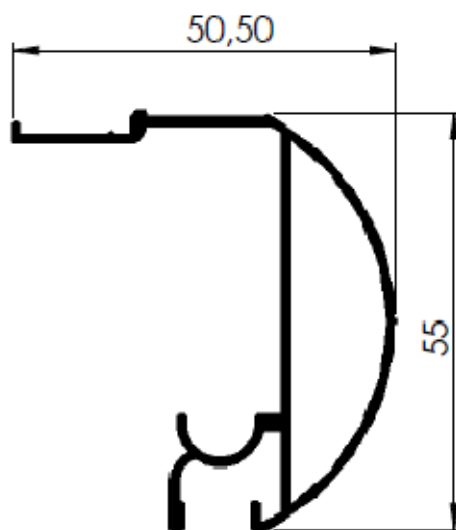

601124938 - PESO 0,559 kg/m
10 BARRAS POR PACOTE

BX 092

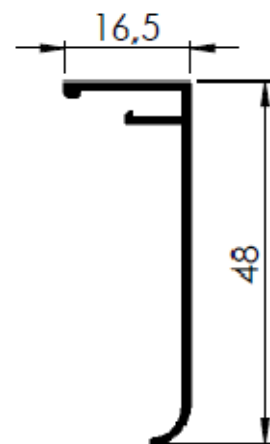

601122981 - PESO 0,180 kg/m
20 BARRAS POR PACOTE

TEMPERADO BOX 8mm

BX 103

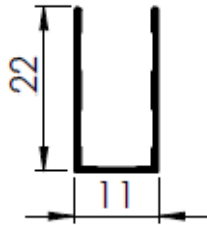

601122986 - PESO 0,116 kg/m
40 BARRAS POR PACOTE

BX 137

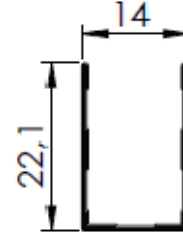

601122988 - PESO 0,126 kg/m
40 BARRAS POR PACOTE

BX 093

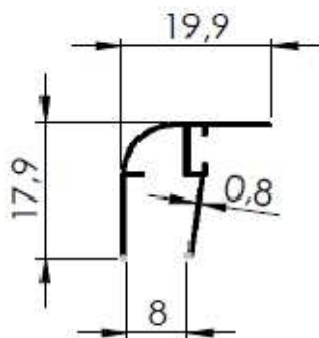

601122982 - PESO 0,131 kg/m
30 BARRAS POR PACOTE

BX 102

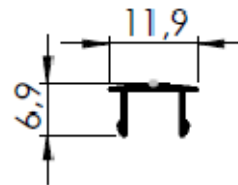

601122984 - PESO 0,057 kg/m
40 BARRAS POR PACOTE

TEMPERADO

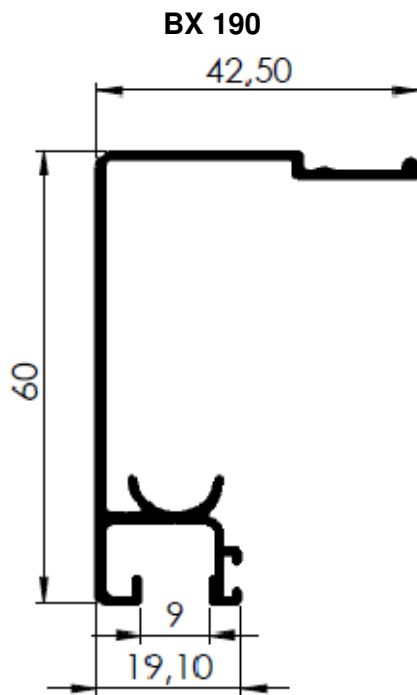

601124881 - PESO 0,514 kg/m
10 BARRAS POR PACOTE

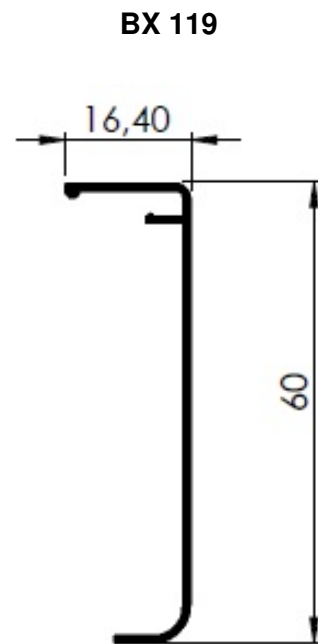

601121680 - PESO 0,220 kg/m
20 BARRAS POR PACOTE

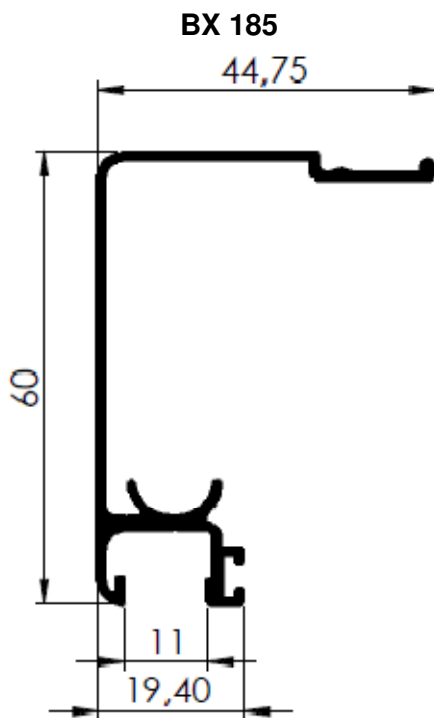

601125012 - PESO 0,514 kg/m
10 BARRAS POR PACOTE

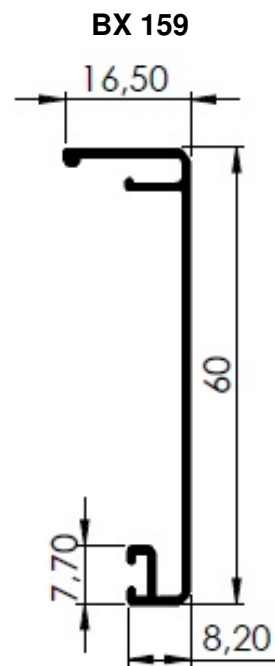

601124883 - PESO 0,245 kg/m
20 BARRAS POR PACOTE

TEMPERADO

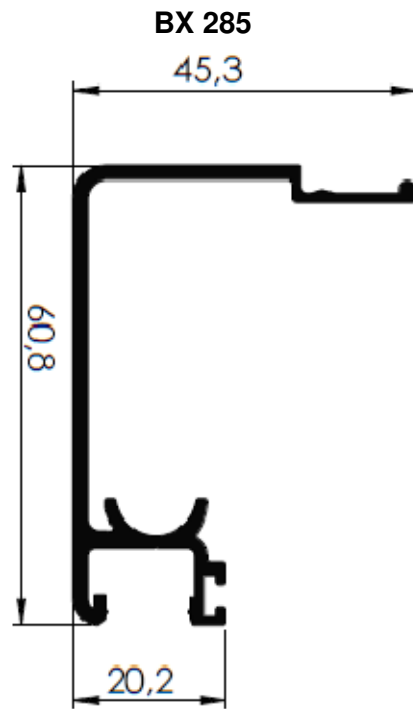

601120019 - PESO 0,768 kg/m
10 BARRAS POR PACOTE

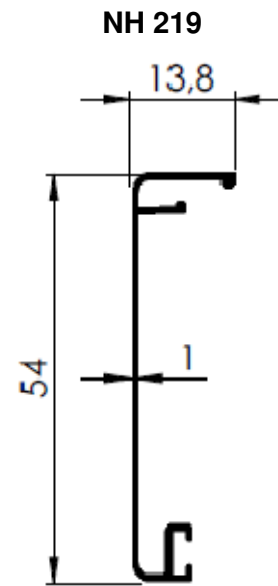

601120004 - PESO 0,260 kg/m
20 BARRAS POR PACOTE

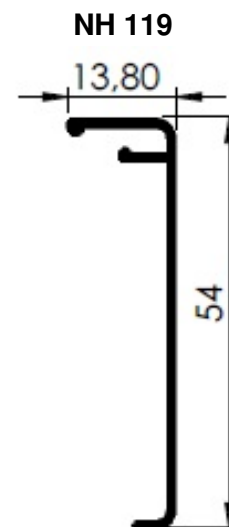

601120002 - PESO 0,221 kg/m
20 BARRAS POR PACOTE

TEMPERADO

NH 190

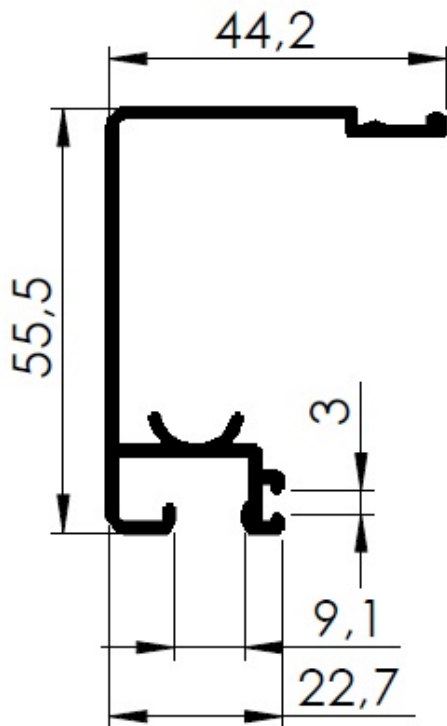

601120001- PESO 0,546 kg/m
10 BARRAS POR PACOTE

NH 390

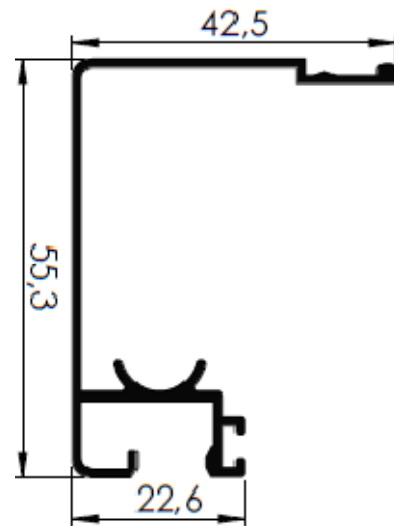

601120022- PESO 0,510 kg/m
10 BARRAS POR PACOTE

NH 290

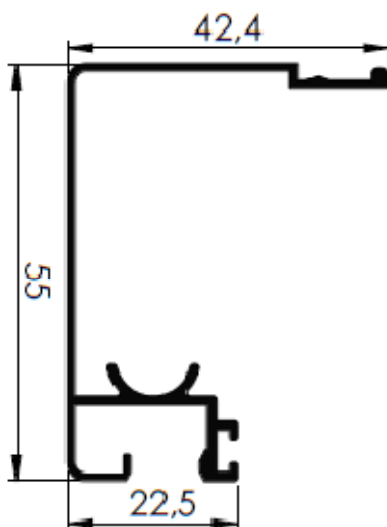

601120021- PESO 0,488 kg/m
10 BARRAS POR PACOTE

NH 159

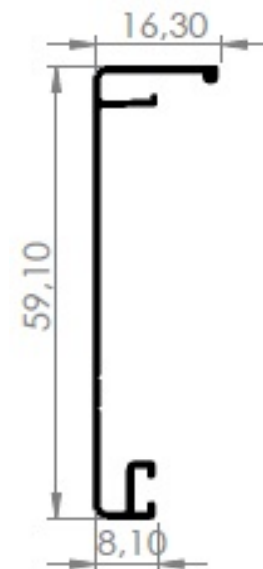

601120011 - PESO 0,288 kg/m
20 BARRAS POR PACOTE

TEMPERADO

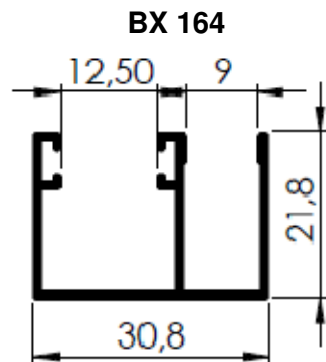

601122015 - PESO 0,318 kg/m
20 BARRAS POR PACOTE

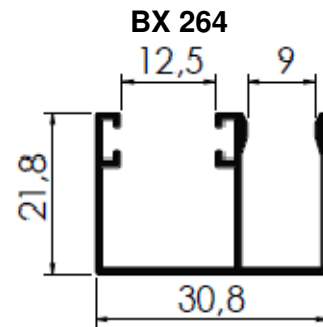

601120018 - PESO 0,293 kg/m
20 BARRAS POR PACOTE

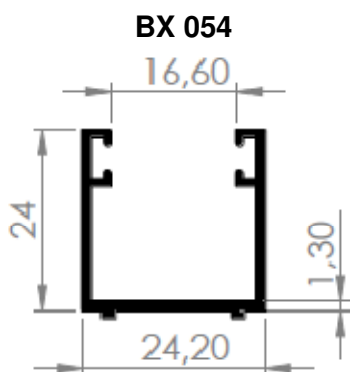

601120014 - PESO 0,308 kg/m
20 BARRAS POR PACOTE

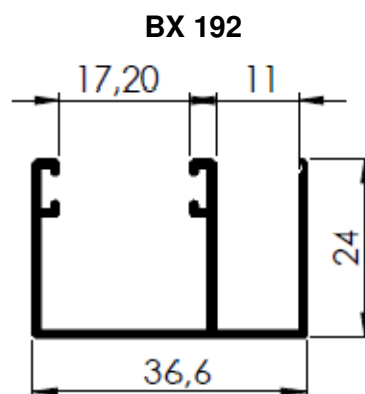

601124882 - PESO 0,368 kg/m
20 BARRAS POR PACOTE

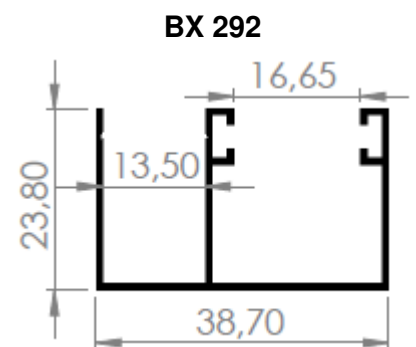

601120010 - PESO 0,335 kg/m
20 BARRAS POR PACOTE

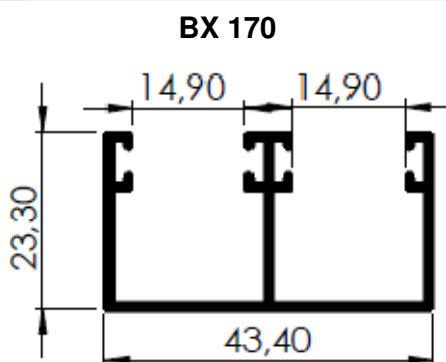

601124751 - PESO 0,475 kg/m
10 BARRAS POR PACOTE

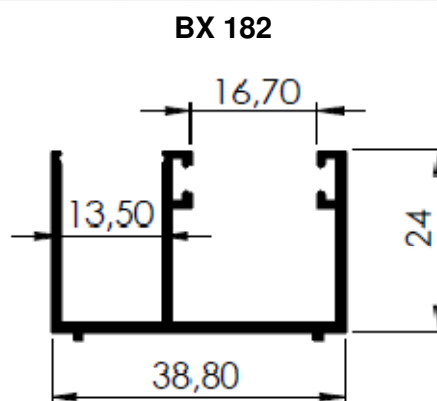

601125017 - PESO 0,410 kg/m
20 BARRAS POR PACOTE

TEMPERADO

BX 155

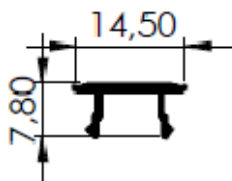

601122985 - PESO 0,090 kg/m
40 BARRAS POR PACOTE

BX 010

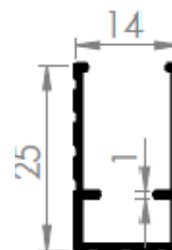

601120017 - PESO 0,178kg/m
20 BARRAS POR PACOTE

PU 040

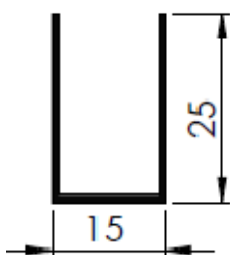

601224681 - PESO 0,176 kg/m
30 BARRAS POR PACOTE

PU 004

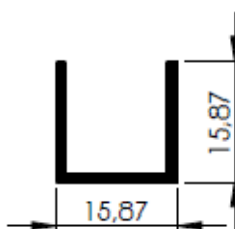

601228715 - PESO 0,148 kg/m
30 BARRAS POR PACOTE

BX 375

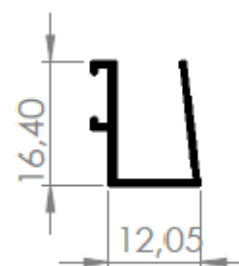

601120015 - PESO 0,121 kg/m
20 BARRAS POR PACOTE

BX 209

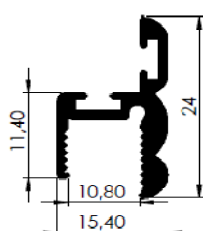

601121678 - PESO 0,245 kg/m
20 BARRAS POR PACOTE

BX 128

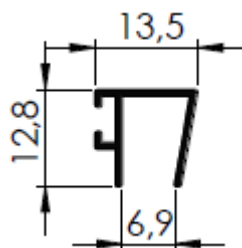

601128770 - PESO 0,108 kg/m
30 BARRAS POR PACOTE

BX 275

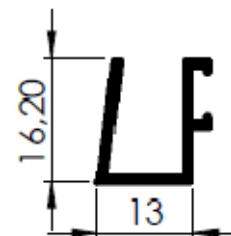

601121679 - PESO 0,180 kg/m
20 BARRAS POR PACOTE

TEMPERADO

BX 130

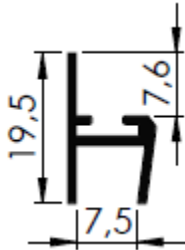

601126868 PESO 0,140 kg/m
30 BARRAS POR PACOTE

BX 131

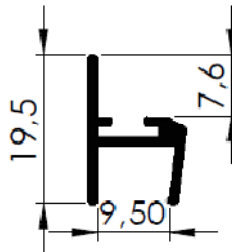

601126867 - PESO 0,154 kg/m
30 BARRAS POR PACOTE

BX 126

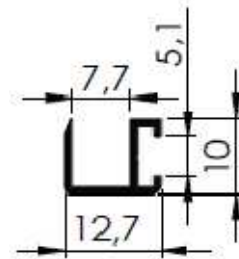

601128767 - PESO 0,100 kg/m
30 BARRAS POR PACOTE

TRILHO SUP. BOX LISO 43,7MMX44,5MM

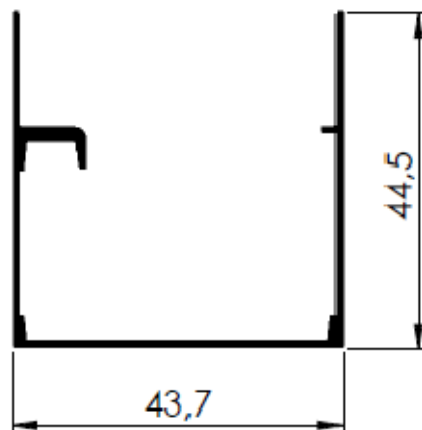

601120013 - PESO 0,468 kg/m
10 BARRAS POR PACOTE

BX 241

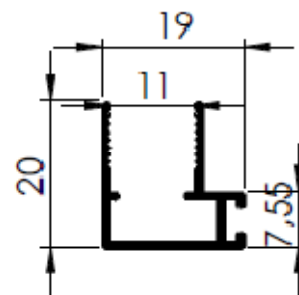

601121682 - PESO 0,190 kg/m
20 BARRAS POR PACOTE

TRAPEZIO PARA POLICARBONATO

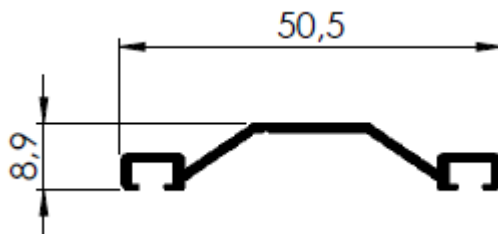

601130018 - PESO 0,294 kg/m
16 BARRAS POR PACOTE

**PU C/ ABA 6MM
(POLICARBONATO)**

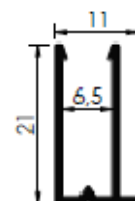

601220006 - PESO 0,152 kg/m
30 BARRAS POR PACOTE

VENEZIANA

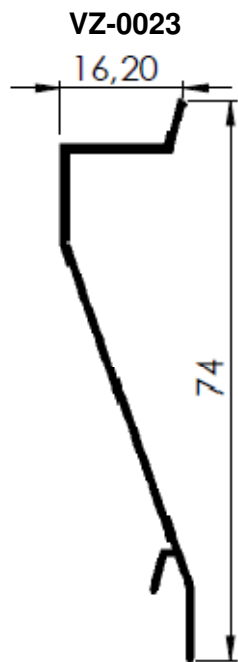

601190002 - PESO 0,250 kg/m
15 BARRAS POR PACOTE

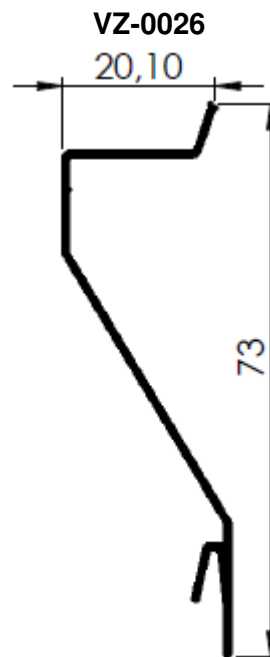

601190001 - PESO 0,293 kg/m
15 BARRAS POR PACOTE

TRILHO PANTOGRÁFICO

1 ROLDANA CONCAVA

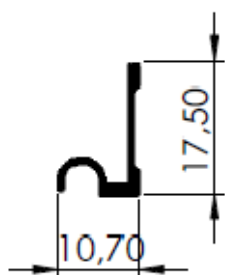

601040240 - PESO 0,099 kg/m
30 BARRAS POR PACOTE

1 ROLDANA RETA

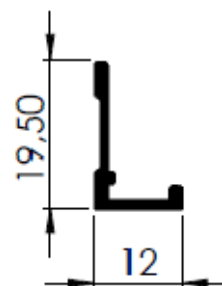

601040242 - PESO 0,146 kg/m
30 BARRAS POR PACOTE

TRILHO PANTOGRÁFICO

2 ROLDANAS CONCAVAS

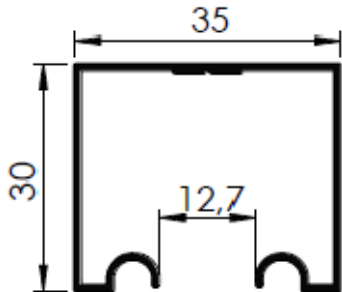

601040008 - PESO 0,333 kg/m
8 BARRAS POR PACOTE

2 ROLDANAS CONCAVAS

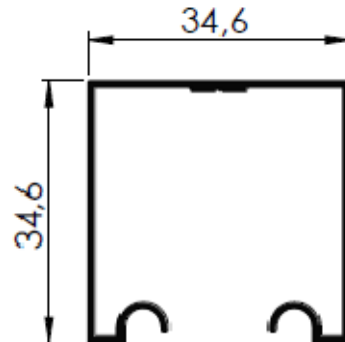

601040009 - PESO 0,334 kg/m
8 BARRAS POR PACOTE

2 ROLDANAS CONCAVAS

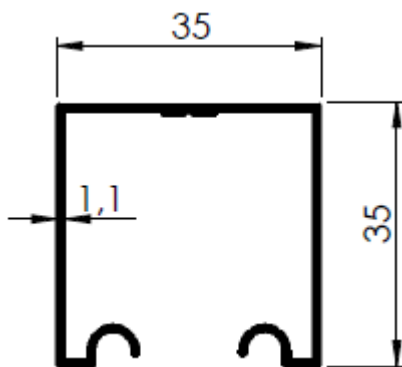

601040001 - PESO 0,388 kg/m
8 BARRAS POR PACOTE

2 ROLDANAS CONCAVAS

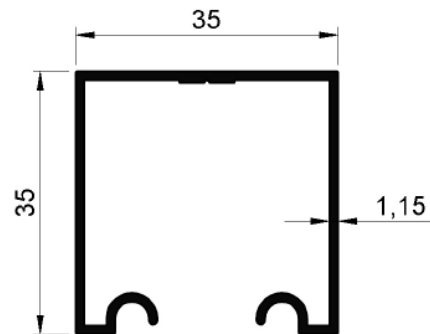

601040010 - PESO 0,441 kg/m
8 BARRAS POR PACOTE

2 ROLDANAS CONCAVAS

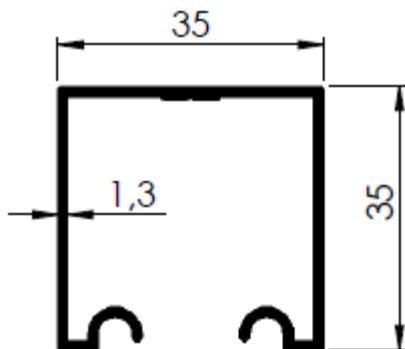

601040002 - PESO 0,460 kg/m
8 BARRAS POR PACOTE

2 ROLDANAS RETAS

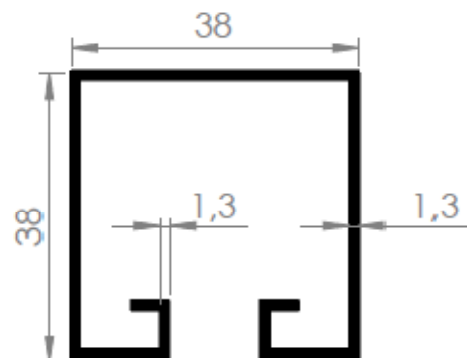

601048554 - PESO 0,588 kg/m
8 BARRAS POR PACOTE

TRILHO PANTOGRÁFICO

2 ROLDANAS CONCAVAS C/ ABAS

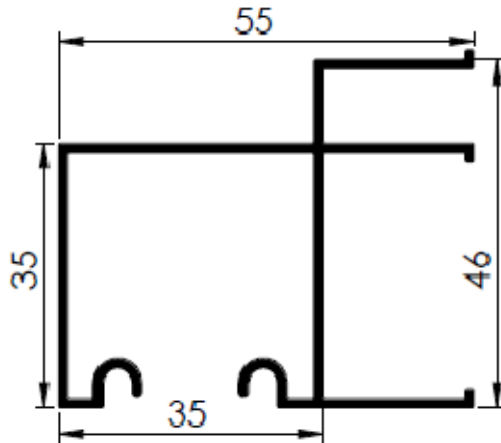

601040005 - PESO 0,726 kg/m
6 BARRAS POR PACOTE

2 ROLDANAS CONCAVAS

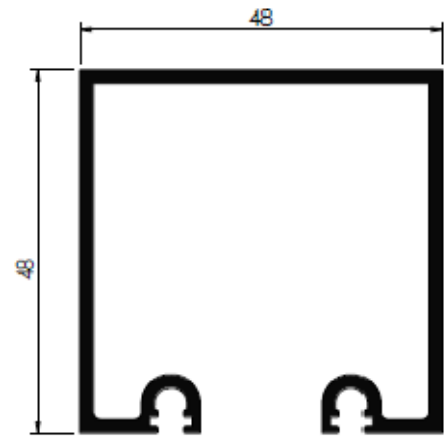

601040003 - PESO 0,976 kg/m
6 BARRAS POR PACOTE

SUPORE P/ TP 02 ROLDANAS 63MMX39MM

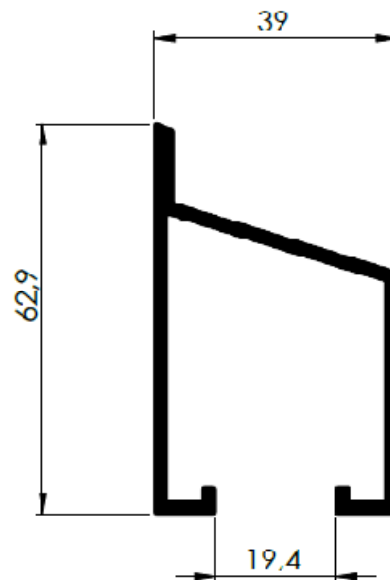

601040006 - PESO 0,937 kg/m
6 BARRAS POR PACOTE

MODULO ESPECIAL (DESLIZANTES)

TRILHO DUPLO P/ CONJ. DESLIZANTE

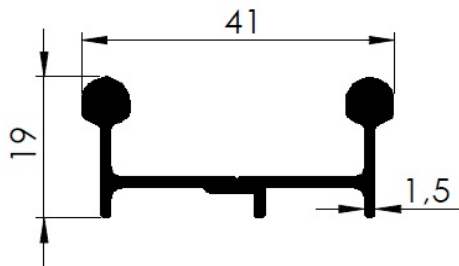

600060004 - PESO 0,490 kg/m
6 BARRAS POR PACOTE

TRANSPASSE 40,8 X 17,8MM

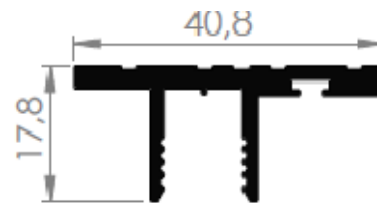

601130067 - PESO 0,493 kg/m
10 BARRAS POR PACOTE

TRILHO TRIPLO P/ CONJUNTO DESLIZANTE

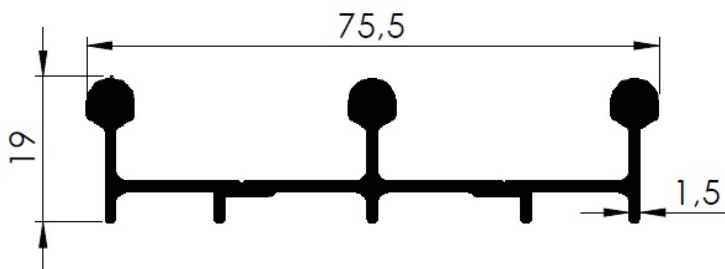

600060005 - PESO 0,828 kg/m

TRILHO SIMPLES P/ CONJ. DESLIZANTE

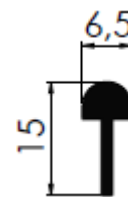

600060007 - PESO 0,128 kg/m
30 BARRAS POR PACOTE

PERFIL "F" DESLIZANTE

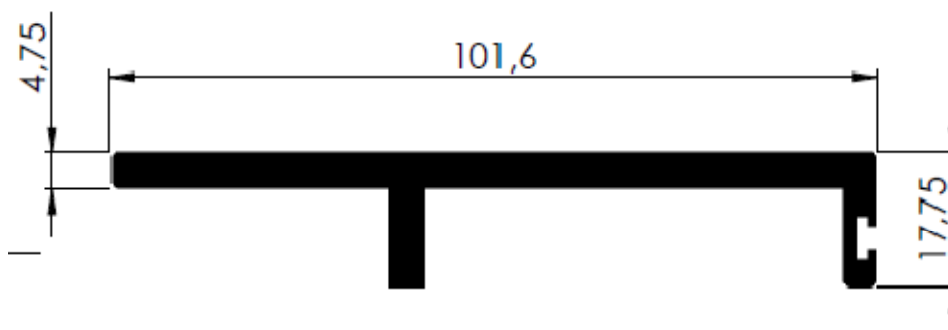

600060006 - PESO 1,684 kg/m
3 BARRAS POR PACOTE

COMPOSIÇÃO E APLICAÇÃO DAS PRINCIPAIS LIGAS COMERCIALIZADAS PELA NOVO HORIZONTE										
LIGA	ELEMENTOS	Cu	Fe	Mg	Mn	Cr	Si	Ti	Zn	Al
6060	% Mínimo		0,10	0,35			0,30			Restante
	% Máximo	0,10	0,30	0,60	0,10	0,05	0,60	0,10	0,15	
6063	% Mínimo			0,45			0,20			Restante
	% Máximo	0,10	0,35	0,90	0,10	0,10	0,60	0,10	0,10	
6060: Perfis para construção civil, ornamentos, caixilharia em geral, móveis, etc.										
6063: Tubos de irrigação, aro para bicicleta, acabamentos para carrocerias, barcos, etc.										
Ambas possuem média resistência mecânica, alta resistência à corrosão, boa conformabilidade (melhor é a 6063) e são apropriadas para anodização decorativa fosca.										

INFORMAÇÕES IMPORTANTES

DICAS PARA ARMAZENAMENTO E CONSERVAÇÃO CORRETA DOS PERFIS DE ALUMÍNIO

- ✓ NUNCA pise nos amarrados/ pacotes de perfis durante a movimentação ou armazenamento e NÃO puxe/ arraste as barras de dentro dos amarrados fechados;
- ✓ Evite a movimentação dos amarrados diretamente com a empilhadeira. Eles devem estar armazenados em cestos/ gaiolas, ou embalagens apropriadas para estes fins;
- ✓ NUNCA movimente ou armazene os amarrados sob chuva, ou em locais com umidades;
- ✓ NUNCA armazene os amarrados, e principalmente os perfis sem embalar, próximo de locais onde fiquem expostos a pó de cimento, pó ocasionado por quebras de paredes, ou ainda próximo à névoa Salina (Soda);
- ✓ Quando armazenar perfis na horizontal, evite pilhas muito altas e separe as camadas com papelão ou travessas adequadas. NUNCA armazene pacotes diretamente ao piso;
- ✓ Para evitar marcas ou riscos superficiais, evite contato direto entre perfis e outros metais;
- ✓ UTILIZE luvas LIMPAS no manuseio. O ideal é que se faça o uso de talco industrial periodicamente durante o turno, para “secar” a luva molhada de suor. Desta forma evita-se mancha alcalina no perfil.